

Register your instrument!  
[www.eppendorf.com/myeppendorf](http://www.eppendorf.com/myeppendorf)



# CryoCube® F740i

Operating manual

Copyright© 2017 Eppendorf AG, Germany. All rights reserved, including graphics and images. No part of this publication may be reproduced without the prior permission of the copyright owner.

Eppendorf® and the Eppendorf Brand Design are registered trademarks of Eppendorf AG, Germany.

Vacupor® is a registered trademark of Porextherm-Dämmstoffe GmbH, Germany.

Microsoft® and Excel® are registered trademarks of Microsoft Corporation in the United States and/or other countries.

CryoCube®, PhysioCare Concept®, and epServices® logo are registered trademarks of Eppendorf AG, Germany.

New Brunswick™ is a trademark of Eppendorf AG, Germany.

Innova® and HEF® are registered trademarks of Eppendorf, Inc., USA.

Registered trademarks and protected trademarks are not marked in all cases with ® or ™ in this manual.

## Table of contents

<b>1</b>	<b>Operating instructions</b>	<b>7</b>
1.1	Using this manual	7
1.2	Danger symbols and danger levels	7
1.2.1	Danger symbols	7
1.2.2	Danger levels	7
1.3	Symbols used	7
<b>2</b>	<b>Safety</b>	<b>9</b>
2.1	Intended use	9
2.2	Warnings for intended use	9
2.2.1	CryoCube F740iw and CryoCube F740hiw	11
2.2.2	CryoCube F740hi and CryoCube F740hiw	11
2.3	Electromagnetic compatibility	11
2.3.1	Europe	11
2.3.2	U.S.A.	11
2.4	Health and Safety at Work Act 1974	12
2.5	Warning symbols on the device	13
2.6	User protection	16
2.7	User profile	16
2.8	Information on product liability	16
<b>3</b>	<b>Product description</b>	<b>17</b>
3.1	Product overview	17
3.1.1	Front view	17
3.1.2	Side view	18
3.1.3	Internal view	19
3.1.4	Water connection	20
3.1.5	Interfaces	21
3.2	Features	22
3.3	Intuitive operating concept	22
3.4	Delivery package	23
3.4.1	Device and accessories	23
3.4.2	Documentation	23
3.5	Accessories	24
3.5.1	Inventory racking systems	24
3.5.2	Safety system	24
3.5.3	Chart recorder	24
<b>4</b>	<b>Installation</b>	<b>25</b>
4.1	Selecting the location	25
4.1.1	Installation instructions for devices with refrigerants R-290 and R-170	26
4.2	Preparing installation	26
4.2.1	Unpacking the device	26
4.2.2	Checking the delivery	26
4.2.3	Transporting the device to the location	26
4.2.4	Installing the device	27

**Table of contents**CryoCube® F740i  
English (EN)

4.3	Installing the device	27
4.3.1	Connecting the device to the voltage supply	27
4.3.2	Remote alarm interface	28
4.3.3	RS-485 interface	28
4.3.4	Ethernet interface	29
4.4	Connecting the device to the water supply	29
4.4.1	Water flow rate	31
4.5	Switching on the device	32
4.5.1	Enabling the safety circuit	32
4.5.2	Switching on the mains/power supply	32
<b>5</b>	<b>Operation</b>	<b>33</b>
5.1	Basic device settings	33
5.1.1	Setting the set temperature of the interior of the device	33
5.1.2	Setting warning limits and alarm limits	33
5.1.3	Setting the alarm delay	33
5.1.4	Enabling the user management	33
5.2	Loading the device	34
5.3	Switching off the device	35
5.3.1	Disabling the safety circuit	35
5.3.2	Disconnecting the device from the voltage supply	35
<b>6</b>	<b>Overview of operating controls</b>	<b>37</b>
6.1	Operating the user interface	37
6.1.1	Home screen	37
6.1.2	Function area	38
6.1.3	Toolbar	38
6.1.4	Information bar	39
6.1.5	Selecting the function	40
6.1.6	Setting the set value	40
6.1.7	Switching between the functions	41
<b>7</b>	<b>Menu area</b>	<b>43</b>
7.1	Alarms	44
7.1.1	Setting alarms and alarm limits	44
7.1.2	Active alarm	46
7.2	Charts	47
7.3	Events	50
7.4	Settings	51
7.4.1	About this Freezer menu item	51
7.4.2	System menu item	52
7.4.3	Device menu item	56
7.5	Contact and Support	57
7.6	Clean Screen	58
7.6.1	Cleaning the touch screen	58
7.7	Export	59

<b>8</b>	<b>User administration</b>	<b>61</b>
8.1	User groups	61
8.2	User management	61
8.2.1	Setting up the user management and creating the first administrator	61
8.2.2	Editing the user management	62
8.2.3	Disabling the user management	63
8.3	Editing user accounts as administrator	64
8.3.1	Creating a user account	64
8.3.2	Editing a user account	64
8.3.3	Deleting a user account	65
8.3.4	Changing the password/PIN of a user account	66
8.3.5	Changing the password/PIN of the administrator	67
8.4	Editing user accounts as User level 1 (Restricted user) and User level 2 (User)	67
8.4.1	Logging off as a user	68
8.4.2	Administrating your own user account	69
<b>9</b>	<b>Maintenance</b>	<b>71</b>
9.1	Warning notices concerning cleaning	71
9.2	Service schedule	71
9.3	Defrosting the device	72
9.4	Cleaning and decontamination	72
9.4.1	Cleaning the device	72
9.4.2	Cleaning and disinfecting the touch screen	73
9.4.3	Cleaning the seals	73
9.4.4	Cleaning the vent tube	73
9.4.5	Cleaning the air filter and the air intake grille	74
9.4.6	Decontaminating the interior and the inner shelves	75
9.5	Lubricating the device	75
9.6	Disassembling the inner shelf from the device	75
9.7	Shipping the device	76
<b>10</b>	<b>Troubleshooting</b>	<b>77</b>
10.1	General errors	77
10.1.1	Outer door	77
10.1.2	Software error messages	77
10.2	Emergency release	78
10.3	After a mains/power failure	78
10.4	Heating of the interior	78
<b>11</b>	<b>Transport, storage and disposal</b>	<b>79</b>
11.1	Transport	79
11.1.1	Preparing the device for transport	80
11.1.2	Transporting the device	80
11.2	Storage	81
11.3	Prepare the device for disposal	81
11.3.1	Disassembling the actuator and the retaining plate	81
11.4	Disposal	81

**Table of contents**CryoCube® F740i  
English (EN)

<b>12</b>	<b>Technical data</b>	<b>83</b>
12.1	Power supply	83
12.2	Ambient conditions	83
12.3	Weight	83
12.4	Dimensions	84
12.4.1	External dimensions	84
12.4.2	Internal dimensions	85
12.4.3	Packing dimensions	86
12.5	Interfaces	87
12.6	Additional specifications	87
12.6.1	Temperature control	87
12.6.2	Interior	87
12.6.3	Materials	87
12.6.4	Cooling	87
12.7	Refrigerant	88
12.8	Water connection	88
<b>13</b>	<b>Ordering information</b>	<b>89</b>
13.1	Device	89
13.2	Accessories	91
13.2.1	Back-up systems	91
13.2.2	Temperature monitoring	91
13.2.3	Chart recorder	91

## 1 Operating instructions







### 1.1 Using this manual

- ▶ Read this operating manual completely before using the device for the first time. Also observe the instructions for use of the accessories.
- ▶ This operating manual is part of the product. Thus, it must always be easily accessible.
- ▶ Enclose this operating manual when transferring the device to third parties.
- ▶ You will find the current version of the operating manual for all available languages on our website under [www.eppendorf.com/manuals](http://www.eppendorf.com/manuals).

### 1.2 Danger symbols and danger levels

#### 1.2.1 Danger symbols

The safety instructions in this manual have the following danger symbols and danger levels:

	Low temperatures		Electric shock
	Heavy load		Risk of crushing
	Hazard point		Material damage

#### 1.2.2 Danger levels

<b>DANGER</b>	<i>Will</i> lead to severe injuries or death.
<b>WARNING</b>	<i>May</i> lead to severe injuries or death.
<b>CAUTION</b>	May lead to light to moderate injuries.
<b>NOTICE</b>	May lead to material damage.

### 1.3 Symbols used

Depiction	Meaning
1. 2.	Actions in the specified order
▶	Actions without a specified order
•	List:
<i>Text</i>	Display or software texts
	Additional information

**Operating instructions**

CryoCube® F740i  
English (EN)



## 2 Safety

### 2.1 Intended use

CryoCube freezers are designed to provide precise, ultra-low temperature environments for storage of scientific materials for research purposes. They are designed to provide ultra-low temperature sample storage from -50 °C to -86 °C at 32 °C maximum ambient operating temperature.

### 2.2 Warnings for intended use

---



**DANGER! Risk of injury due to tilting of the device.**

If the device tips over and falls on a person, the person may sustain fatal injuries.

- ▶ Transport the device with a sufficient number of helpers.
- ▶ Do not transport the device over ramps at an angle > 17 % (10°). Transport the device sideways over ramps.
- ▶ Only lift the device with a transport aid.



**WARNING! Risk of explosion.**

- ▶ Do not operate the device in areas where work is completed with explosive substances.
- ▶ Do not use this device to store any explosive or highly reactive substances.
- ▶ Do not use this device to store any substances which could create an explosive atmosphere.



**WARNING! Lethal voltages inside the device.**

Touching parts which are under high voltage may cause an electric shock. An electric shock injures the heart and causes respiratory paralysis.

- ▶ Ensure that the housing is closed and undamaged.
- ▶ Do not remove the housing.
- ▶ Ensure that no liquid can penetrate into the device.

Only authorized service staff may open the device.



**WARNING! Electric shock due to damage to device or mains/power cord.**

- ▶ Only switch on the device if the device and the mains/power cord are undamaged.
- ▶ Only use devices that have been properly installed or repaired.
- ▶ In case of danger, disconnect the device from the mains supply. Disconnect the mains/power plug from the device or the earth/grounded socket. Use the isolating device intended for this purpose (e.g., the emergency switch in the laboratory).

**Safety**

CryoCube® F740i  
English (EN)

**WARNING! Risk from incorrect voltage supply.**

- ▶ Only connect the device to voltage supplies which correspond with the electrical requirements on the name plate.
- ▶ Only use sockets with a protective earth (PE) conductor and a suitable mains/power cord.

**WARNING! Damage to health due to infectious liquids and pathogenic germs.**

- ▶ When handling infectious liquids and pathogenic germs, observe the national regulations, the biological safety level of your laboratory, the material safety data sheets, and the manufacturer's application notes.
- ▶ Wear your personal protective equipment.
- ▶ Consult the "Laboratory Biosafety Manual" (source: World Health Organization, Laboratory Biosafety Manual, in its respectively current valid version).

**CAUTION! Risk of burns from direct contact with cold surfaces.**

The temperature inside the device is low. Direct contact with the interior or samples can cause skin burns.

- ▶ Wear cold protection gloves when loading and unloading the device.

**CAUTION! Risk of crushing your fingers when closing the outer door.**

- ▶ Do not place your fingers between the device and the outer door.
- ▶ Do not touch the peg and the covers of the door lock when closing the outer door.

**NOTICE! Radio interference.**

This device is a category A product in accordance with EN 55011. There may be disturbance to radio reception in residential areas.

- ▶ Ensure that appropriate preventive measures are taken.

**NOTICE! Damage to electronic components due to condensation.**

Condensate can form in the device after it has been moved from a cool environment to a warmer environment.

- ▶ After installing the device, wait for at least 6 h. Only then connect the device to the mains/power line.

**NOTICE! Damage to device or malfunctions due to a damaged touch screen.**

- ▶ Do not operate the device.
- ▶ Switch off the device, disconnect the mains/power plug and have the touch screen replaced by a service technician who has been authorized by Eppendorf.

## 2.2.1 CryoCube F740iw and CryoCube F740hiw

---



**NOTICE! Damage to device due to a blocked water inlet.**

If the water inlet into the device is blocked, the heat exchanger and the condenser may become damaged. The device will no longer cool properly. The refrigerated material can be damaged.

- ▶ Clean or replace the filter at the water inlet.
- 

## 2.2.2 CryoCube F740hi and CryoCube F740hiw

---



**WARNING! Risk of explosion from leaking combustible refrigerants (R-170 and R-290).**

Refrigerant may leak out if a refrigeration cycle is faulty. The refrigerants R-170 and R-290 are combustible and can form explosive mixtures with the ambient air.

- ▶ Ensure that there is adequate ventilation of the location.
  - ▶ Observe the regulations of the owner.
- 

## 2.3 Electromagnetic compatibility

### 2.3.1 Europe

This is a class A product. In a domestic environment this product may cause radio interference in which case the user may be required to take adequate measures.

### 2.3.2 U.S.A.

Any modification or changes made to this device, unless explicitly approved by Eppendorf, will invalidate the authorization of this device. Operation of an unauthorized device is prohibited under Section 302 of the Communications Act of 1934, as amended, and Subpart I of Part 2 of Chapter 47 of the Code of Federal Regulations.

This equipment has been tested and found to comply with the limits for a Class A digital device, pursuant to Part 15 of the FCC Rules. These limits are designed to provide reasonable protection against harmful interference when the equipment is operated in a commercial environment. This equipment generates, uses, and can radiate radio frequency energy and, if not installed and used in accordance with the operating manual, may cause harmful interference to radio communications. Operation of this equipment in a residential area is likely to cause harmful interference in which case the user will be required to correct the interference at his own expense.

## 2.4 Health and Safety at Work Act 1974

Valid in the UK

The Eppendorf AG is a manufacturer and suppliers of laboratory equipment. The Eppendorf AG is obliged under the terms of the above Act to provide our users with instructions on the safe installation, operation and maintenance of the devices.

The devices are designed to acceptable standards and does not entail any hazard if used, as advised in the attached instructions.

The following safety precautions should be observed by all personnel using this equipment:

- Read and understand this operating manual. If in doubt, contact your local Eppendorf sales office.
- Do not remove any covers. There are no operable controls other than those referred to in this operating manual. There are voltages in excess of 41.5 V behind the covers.
- Observe good housekeeping practices, always keeping the equipment and the adjacent areas clean, dry and uncluttered.
- Should any malfunctions occur or be suspected, immediately call a qualified service technician to investigate.
- The hydrocarbon (Group A3) refrigerants used in these freezers are flammable and therefore appropriate notice must be paid to avoid leaks and to keep the freezer away from sparks and flames.

Any person involved with working on or entering the refrigeration circuit should hold a current and valid certificate from an industry-accredited assessment authority which authorizes his/her competence to handle refrigerants (including hydrocarbons) safely in accordance with local regulations and legislation.

## 2.5 Warning symbols on the device

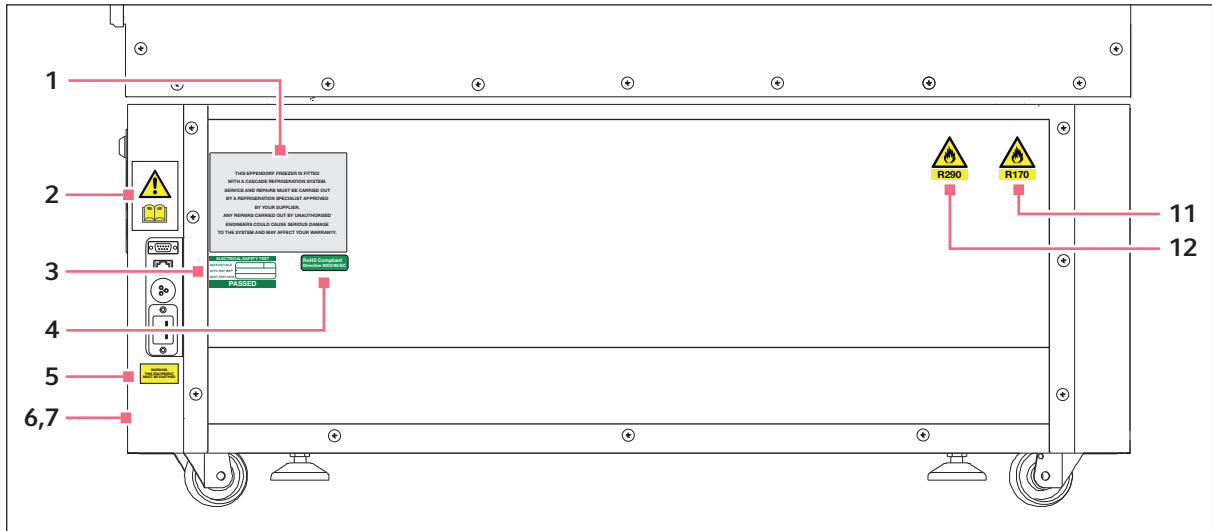

Fig. 2-1: Warning symbols on the rear panel and right side panel

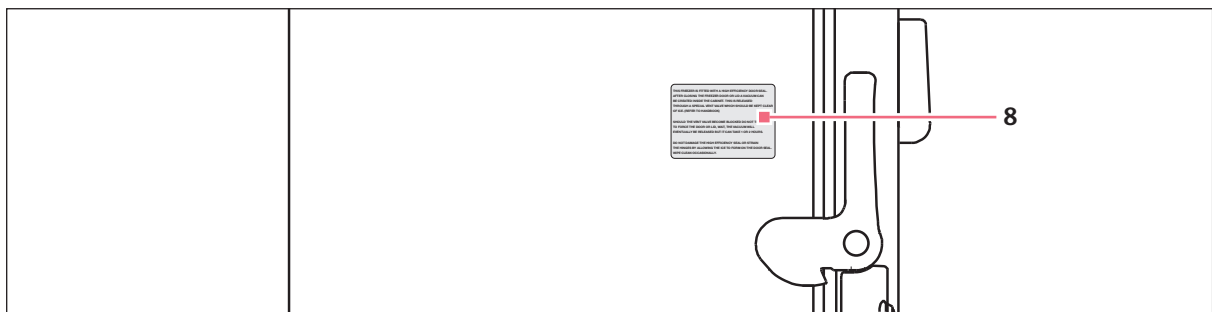

Fig. 2-2: Warning symbol on the door handle

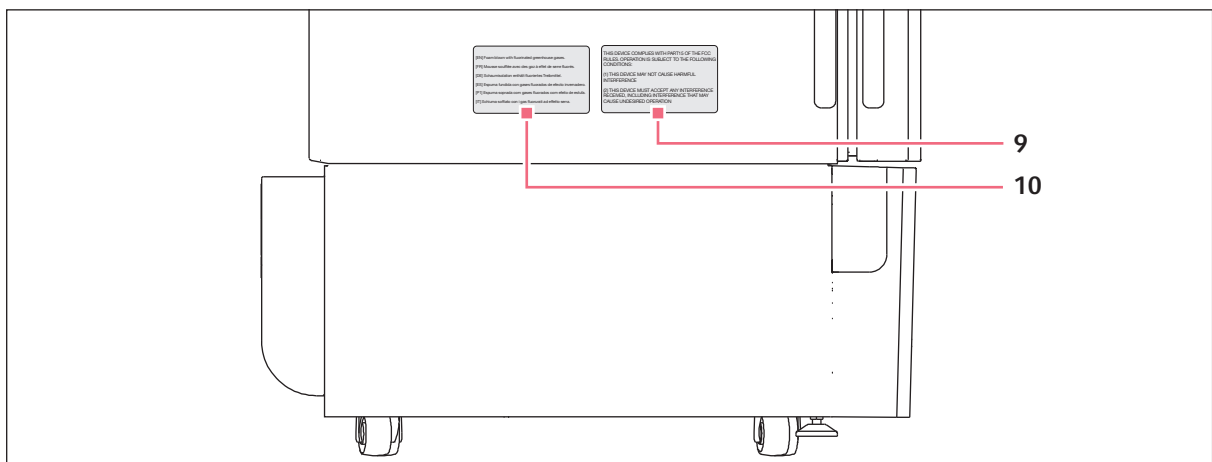







Fig. 2-3: Warning symbols on the left side panel

## Safety

CryoCube® F740i  
English (EN)

	Warning symbol	Meaning
1	<p>THIS EPPENDORF FREEZER IS FITTED WITH A CASCADE REFRIGERATION SYSTEM. SERVICE AND REPAIRS MUST BE CARRIED OUT BY A REFRIGERATION SPECIALIST APPROVED BY YOUR SUPPLIER. ANY REPAIRS CARRIED OUT BY UNAUTHORISED ENGINEERS COULD CAUSE SERIOUS DAMAGE TO THE SYSTEM AND MAY AFFECT YOUR WARRANTY.</p>	<p>The device may only be serviced and repaired by a qualified refrigeration specialist who has been authorized by Eppendorf AG.</p> <p>If the device is serviced or repaired by an unauthorized person, liability on the part of Eppendorf AG shall cease immediately.</p>
2		<p>Notice of a hazard point.</p> <p>Read the operating manual.</p>
3	<p><b>ELECTRICAL SAFETY TEST</b></p> <p>DATE/INITIALS <input type="text"/></p> <p>APPL/REF No. <input type="text"/></p> <p>NEXT TEST DATE <input type="text"/></p> <p><b>PASSED</b></p>	<p>The device has passed the electrical safety test.</p>
4	<p><b>RoHS Compliant</b> Directive 2002/95/EC</p>	<p>The device complies with the RoHS Directive 2002/95/EC.</p>
5	<p><b>WARNING</b> <b>THIS EQUIPMENT</b> <b>MUST BE EARTHED</b></p>	<p>The device may only be connected to a power supply with PE conductor.</p>
6		<p>Risk of electric shock.</p>
7	<p><b>Danger</b> Disconnect the mains supply before removing this cover</p> 	<p>Risk of electric shock.</p> <p>Disconnect the mains/power cord before removing the cover.</p>

	Warning symbol	Meaning
8	<p>THIS FREEZER IS FITTED WITH A HIGH EFFICIENCY DOOR SEAL. AFTER CLOSING THE FREEZER DOOR OR LID A VACUUM CAN BE CREATED INSIDE THE CABINET. THIS IS RELEASED THROUGH A SPECIAL VENT VALVE WHICH SHOULD BE KEPT CLEAR OF ICE. (REFER TO HANDBOOK)</p> <p>SHOULD THE VENT VALVE BECOME BLOCKED DO NOT TRY TO FORCE THE DOOR OR LID, WAIT, THE VACUUM WILL EVENTUALLY BE RELEASED BUT IT CAN TAKE 1 OR 2 HOURS.</p> <p>DO NOT DAMAGE THE HIGH EFFICIENCY SEAL OR STRAIN THE HINGES BY ALLOWING THE ICE TO FORM ON THE DOOR SEAL. WIPE CLEAN OCCASIONALLY.</p>	<p>The outer door of the device is fitted with a high efficiency seal. After closing the outer door or the lid a negative pressure can be created inside the device. This is released through a vent valve. Keep the vent valve clear of ice. Should the vent valve become blocked, do not try to force open the outer door or the lid. Wait until pressure compensation has taken place. The balancing of pressure can take 1 to 2 hours.</p> <p>The formation of ice in the seal can damage the seal and hinges. To avoid damage, clean the seal to remove ice.</p>
9	<p>THIS DEVICE COMPLIES WITH PART 15 OF THE FCC RULES. OPERATION IS SUBJECT TO THE FOLLOWING CONDITIONS:</p> <p>(1) THIS DEVICE MAY NOT CAUSE HARMFUL INTERFERENCE</p> <p>(2) THIS DEVICE MUST ACCEPT ANY INTERFERENCE RECEIVED, INCLUDING INTERFERENCE THAT MAY CAUSE UNDESIRE OPERATION</p>	<p>The device complies with the <i>FCC Rules Part 15</i>.</p> <p>The device may be operated under the following conditions:</p> <ul style="list-style-type: none"> <li>• This device may not cause harmful interference.</li> <li>• This device must accept any interference received. This includes interference that may cause undesired operation.</li> </ul>
10	<p>[EN] Foam blown with fluorinated greenhouse gases.</p> <p>[FR] Mousse soufflée avec des gaz à effet de serre fluorés.</p> <p>[DE] Schaumisolation enthält fluoriertes Treibmittel.</p> <p>[ES] Espuma fundida con gases fluorados de efecto invernadero.</p> <p>[P1] Espuma soprada com gases fluorados com efeito de estufa.</p> <p>[IT] Schiuma soffiata con i gas fluorurati ad effetto serra.</p>	<p>Foam blown with fluorinated greenhouse gases.</p>
11		<p>CryoCube F740hi and CryoCube F740hiw: Danger from combustible refrigerant R-170.</p>
12		<p>CryoCube F740hi and CryoCube F740hiw: Danger from combustible refrigerant R-290.</p>

## 2.6 User protection

Personal protective equipment protects your life and your health.

- ▶ Always wear protective clothing, protective gloves, and safety boots.
- ▶ If additional protective equipment is required, this is indicated above the respective instruction.
- ▶ Always wear the personal protective equipment required for the biosafety level and by the laboratory regulations.

## 2.7 User profile

The device and accessories may only be operated by trained and skilled personnel.

Before using the device, read the operating manual carefully and familiarize yourself with the device's mode of operation.

## 2.8 Information on product liability

In the following cases, the designated protection of the device may be compromised. Liability for any resulting property damage or personal injury is then transferred to the operator:

- The device is not used in accordance with the operating manual.
- The device is used outside of its intended use.
- The device is used with accessories or consumables which are not recommended by Eppendorf.
- The device is maintained or repaired by people not authorized by Eppendorf.
- The user makes unauthorized changes to the device.



**3 Product description**  
**3.1 Product overview**  
**3.1.1 Front view**

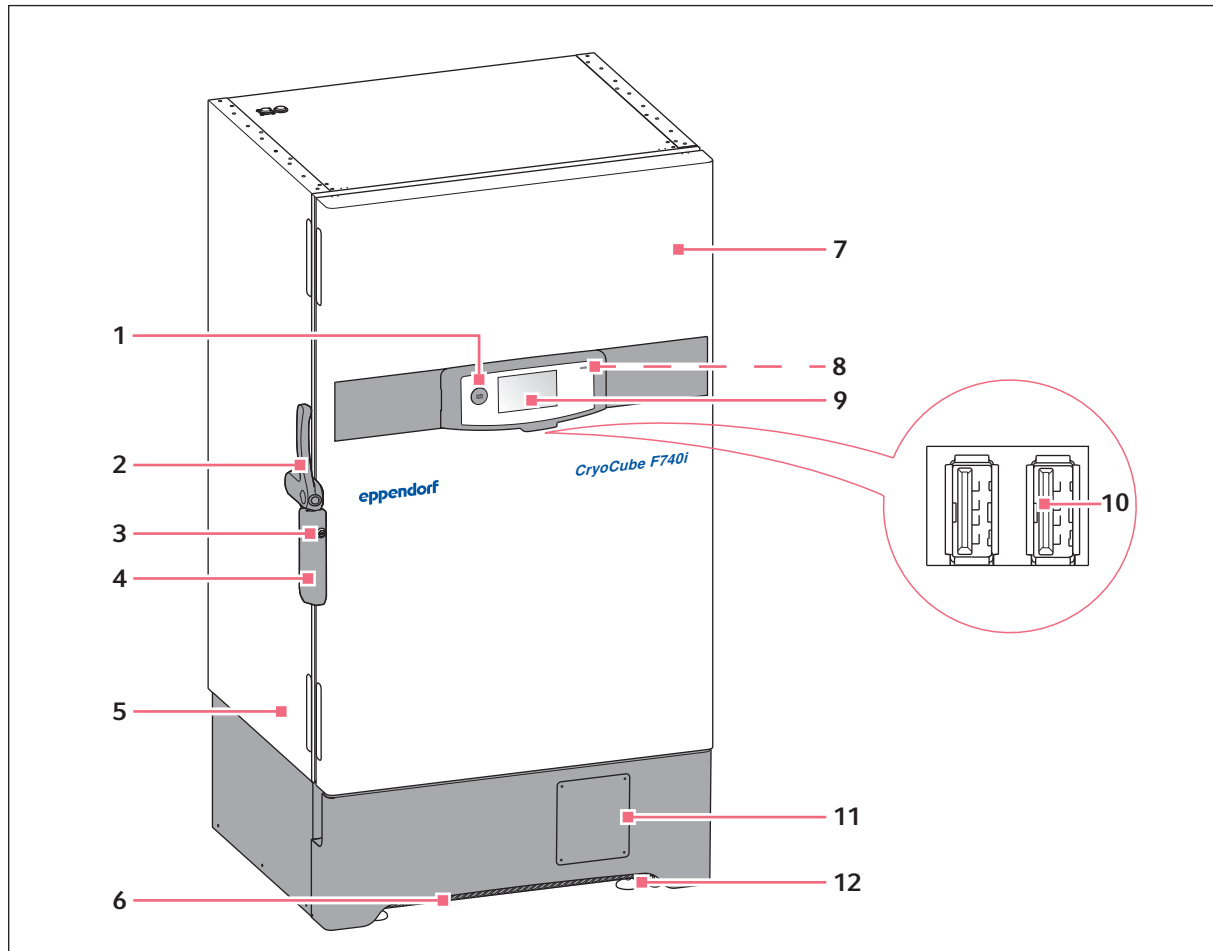

Fig. 3-1: Front view of a model with the outer handle mounted on the left side

- |   |  |
|---|--|
| <b>1 auto vent valve</b><br>Automatic pressure compensation     | <b>7 Outer door</b>  |
| <b>2 Door handle</b>  | <b>8 LED</b><br>Flashes in the event of a mains/power outage |
| <b>3 Mechanical lock</b><br>Emergency release of the outer door | <b>9 Touch screen</b><br>How the device is operated          |
| <b>4 Electronic lock</b>  | <b>10 USB ports</b>  |
| <b>5 Name plate</b>   | <b>11 Position of the optional chart recorder</b>            |
| <b>6 Air filter</b>   | <b>12 Leveling feet</b>                                      |

### 3.1.2 Side view

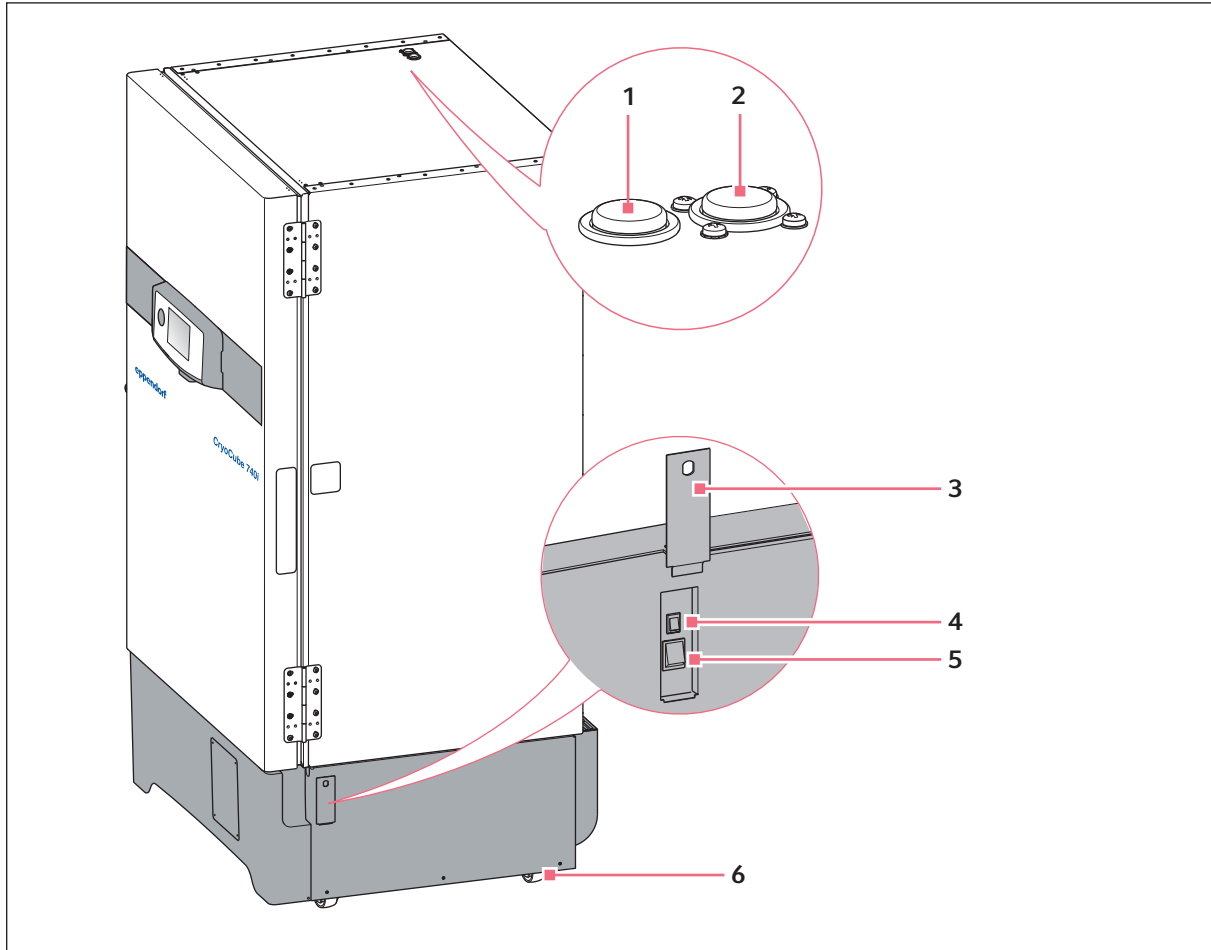

Fig. 3-2: Side view

- |   |  |
|---|--|
| <p><b>1 Access port</b><br/>for external sensors</p>  | <p><b>4 Battery switch</b><br/>For enabling the safety circuit</p> |
| <p><b>2 Access port</b><br/>for external sensors or an optional safety system</p>                       | <p><b>5 Mains/power switch</b></p>                                 |
| <p><b>3 Switch locking plate</b><br/>Lockable plate cover for mains/power switch and battery switch</p> | <p><b>6 Heavy-duty castors</b></p>                                 |

### 3.1.3 Internal view

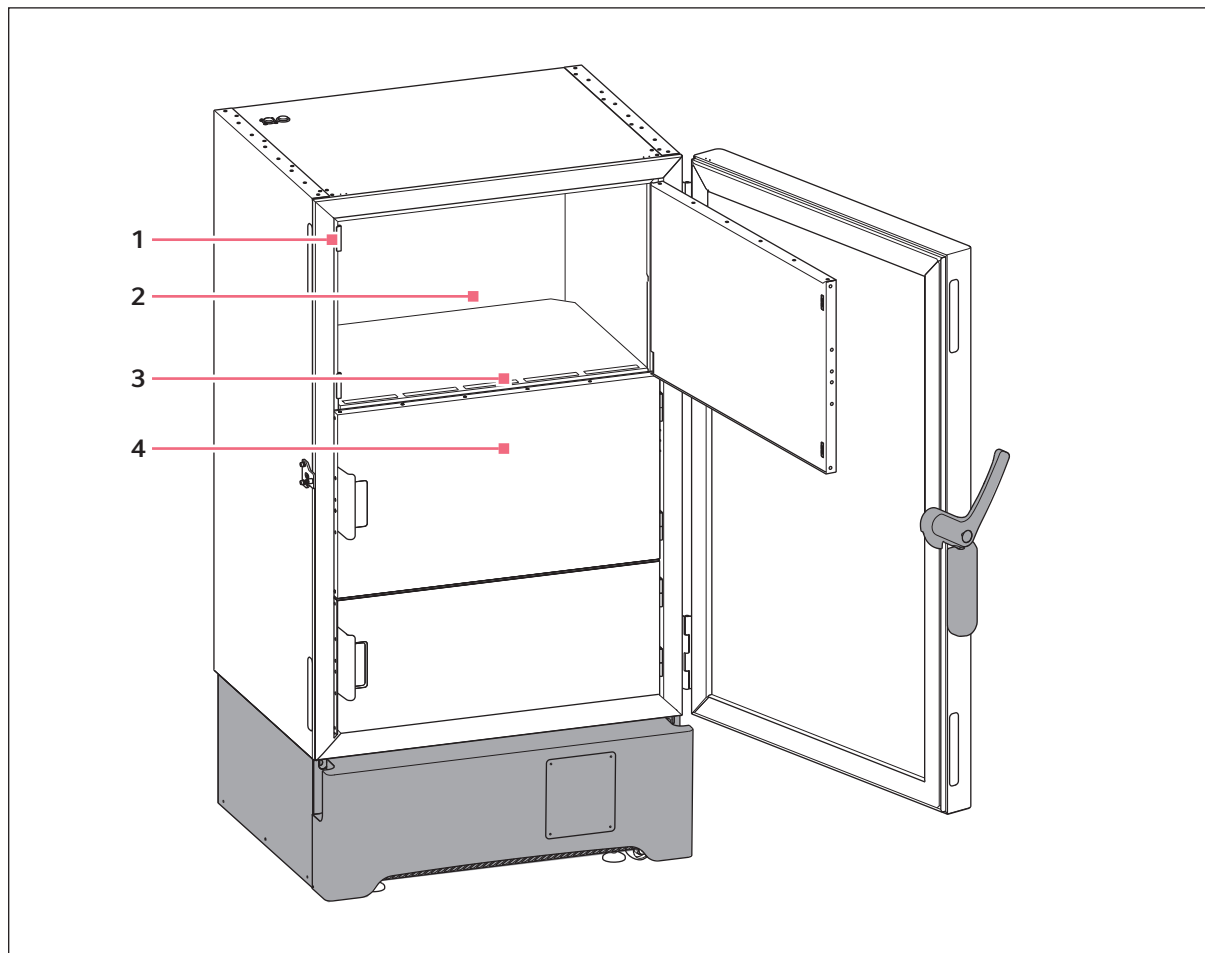

Fig. 3-3: Internal view of a model with three inner doors

**1** Magnetic closure of inner door

**3** Inner shelf

**2** Inner compartment

**4** Inner door

### 3.1.4 Water connection

The CryoCube F740hiw and CryoCube F740iw devices have water cooling connections.

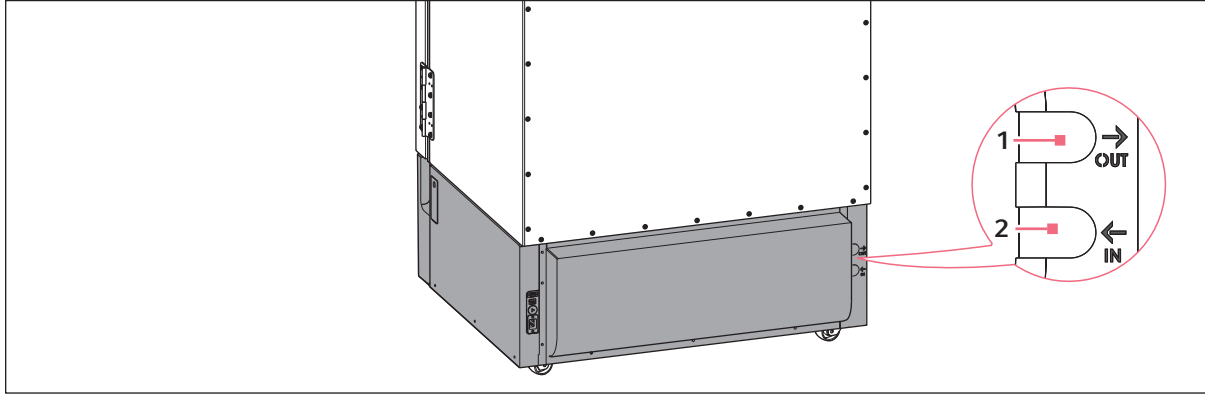

Fig. 3-4: Water connection

**1 Connection for the water outlet from the device**

**2 Connection for the water inlet into the device**

### 3.1.5 Interfaces

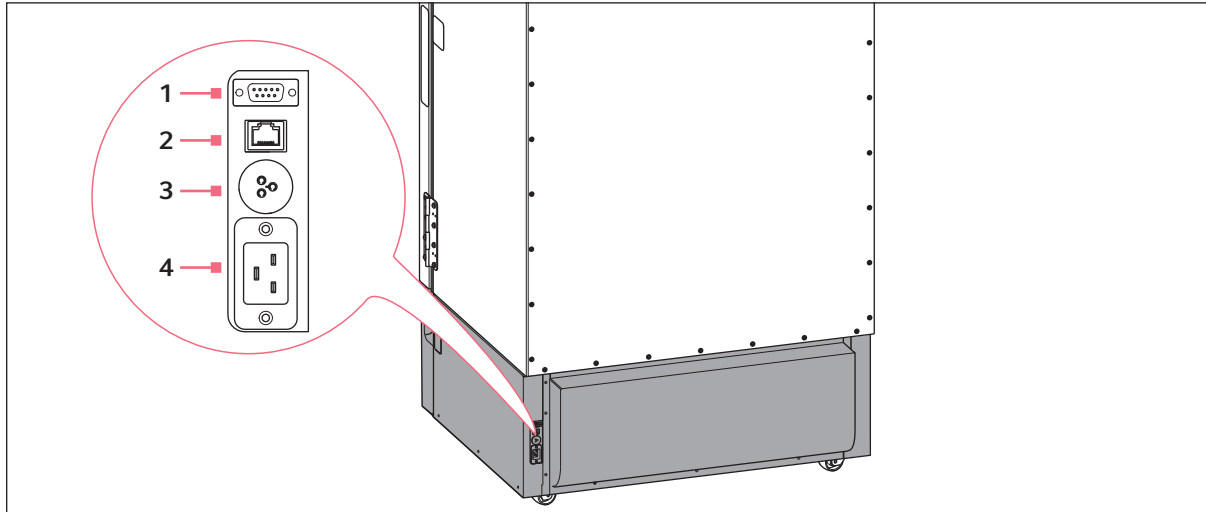

Fig. 3-5: Interfaces

- |  |   |
|--|---|
| <b>1 RS-485 serial interface</b><br>Connection to a building management system or an external system                                 | <b>3 BMS remote alarm interface</b><br>Connection to a building management system<br>Alarms are transmitted to the building management system, e.g., in the event of a mains/power outage |
| <b>2 Ethernet interface</b><br>Connection to an external monitoring system<br>The device can be monitored via the monitoring system. | <b>4 Mains/power connection</b><br>Port for mains/power cord  |

Only devices which meet the requirements of IEC 950/EN 60950-1 (UL 1950) standards may be connected to the interfaces.

**Product description**

CryoCube® F740i

English (EN)

### 3.2 Features

The CryoCube F740i is a freezer for the storage of biological samples.

The CryoCube F740i has a two-stage cascade refrigeration system with two closed refrigeration cycles.

The device is operated via the touch screen. There are several USB ports below the touch screen.

The outer door is locked and unlocked via the software. The outer door can be mechanically unlocked with the emergency release key.

The CryoCube F740i features an automatic pressure compensation. Automatic pressure compensation takes place as soon as the outer door is closed. Afterwards, the outer door can be opened again. Automatic pressure compensation can also be triggered with the *auto vent* valve.

Each compartment is equipped with an inner door with a gasket. With the inner doors closed, cold air loss is minimized and ice formation inside the device is reduced.

The device is equipped with 2 or 4 inner shelves. The number and position of the inner shelves cannot be changed.

The CryoCube F740i features a switch locking plate. The mains/power switch and the battery switch are located behind the lockable cover.

The device can communicate with external systems via the interfaces. Alarms and other parameters are transmitted.

An air filter is located below the outer door. The air filter protects the condenser and the components behind it against contamination and dirt.

The heavy-duty castors serve to transport the device safely to its place of installation. The leveling feet ensure the stability and the horizontal alignment of the device.

### 3.3 Intuitive operating concept

Eppendorf offers a cross-product operating concept which supports swift familiarization with different Eppendorf products. For different Eppendorf products, the basic operating controls are compatible with each other by using an intuitive touch user interface.

### 3.4 Delivery package

#### 3.4.1 Device and accessories

Quantity	Description
1	ULT upright freezer
1	Mains/power cord
1	Safety clamp for mains/power cord
2	Key for switch locking plate
2	Key for emergency release
2	Anti slip pads
1	Plug for connection to the building management system
1	Screwdriver

#### 3.4.2 Documentation

Quantity	Description
1	Operating manual
1	Unpacking instructions
1	Certificate of conformity

**Product description**

CryoCube® F740i  
English (EN)

### 3.5 Accessories

Optional accessories can be ordered separately.

#### 3.5.1 Inventory racking systems

Eppendorf offers a wide selection of inventory racking systems made of stainless steel or aluminum. Inventory racking systems are placed on the inner shelves inside the device.

#### 3.5.2 Safety system

In the event of a mains/power outage, the battery-powered safety system temporarily ensures the safety of the samples. The safety system cools the interior over a limited period of time. The safety system is connected via the access port.

The following systems are available:

- CO<sub>2</sub> safety system
- LN<sub>2</sub> back-up system

#### 3.5.3 Chart recorder

The chart recorder records the temperature on a disk over a period of 7 days. The port for connection of the chart recorder is available in the device.



## 4 Installation

### 4.1 Selecting the location

Information on ambient conditions, dimensions and weights can be found in the technical data.

Select the location for the device according to the following criteria:

- Mains/power connection in accordance with the name plate.
- The ambient conditions match the specifications set out in the Technical data chapter.
- The location is well ventilated.
- The location is not next to heat sources.
- There is an adequate amount of space available for the device. The minimum distances to other devices and walls is 150 mm.
- The floor is level and designed for the weight of the device.
- The device mains/power switch and the cutting unit of the power system circuit (e.g., residual current circuit breaker) can be accessed during operation.

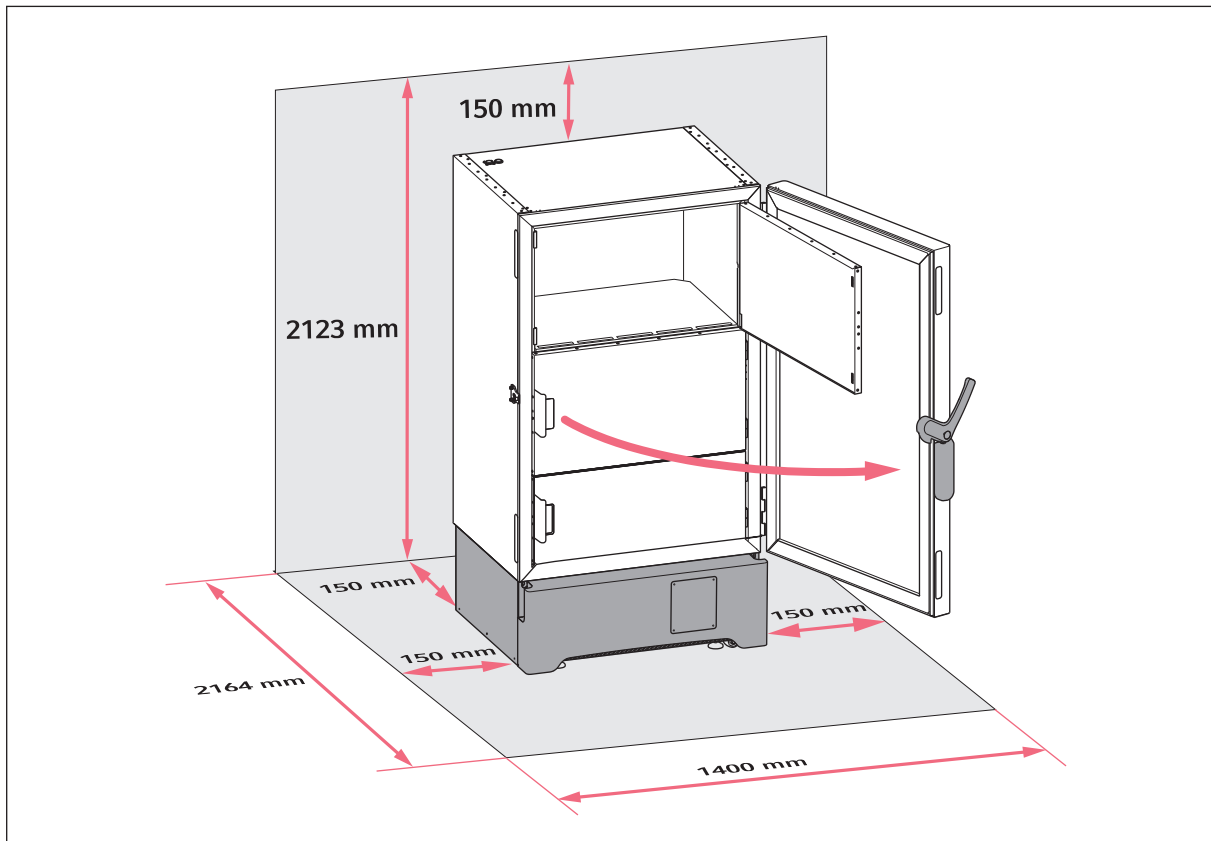

Fig. 4-1: Footprint

**Installation**

CryoCube® F740i  
English (EN)

**4.1.1 Installation instructions for devices with refrigerants R-290 and R-170**

The CryoCube F740hi and CryoCube F740hiw devices contain the refrigerants R-290 and R-170. The refrigerants R-290 and R-170 are combustible and can form explosive mixtures with the ambient air.

If a leak occurs in the refrigeration cycle, no ignitable gas/air mixture may be formed at the location of the device. To avoid the formation of an ignitable gas/air mixture, you can take the following measures:

- Sufficient air volume.
- Controlled ventilation and venting of the location.  
Observe the regulations of the owner.

The refrigeration cycles of the device contain less than 0.15 kg of refrigerant. Access to and use of the room in which the device is located is not restricted according to EN 378.



Contact your safety officer for information on further requirements when installing the device.

**4.2 Preparing installation****NOTICE! Damage as a result of incorrect packing.**

Eppendorf AG is not liable for damage caused by improper packing.

- ▶ The device may only be stored and transported in its original packaging.

**4.2.1 Unpacking the device**

1. Check the packaging for damage.
2. Unpack the device in accordance with the unpacking instructions.

**4.2.2 Checking the delivery**

1. Check the delivery for completeness.
2. Check the device and the accessories for damage that may have occurred during transport.
3. Do not commission the device if the packing or the device are damaged. Contact the Eppendorf AG customer service or your local dealer.

**4.2.3 Transporting the device to the location**

Personal protective equipment

- Protective clothing, safety shoes.

Prerequisites

- The location meets the requirements.
- The device has been unpacked.
- The transport protection has been mounted on the control panel.

- ▶ Transport the device to the location (see *Transport on p. 79*).

#### 4.2.4 Installing the device

Personal protective equipment

- Protective clothing, safety shoes.

Tools and auxiliary equipment

- Spirit level
- Open-end wrench

1. Position the device taking the required minimum distances into account.
2. Fit the anti-slip pads on the leveling feet.
3. Use the open-end wrench to turn the leveling feet downward.
4. Level the device.

The device is standing stable without slipping.

#### 4.3 Installing the device



**WARNING! Risk from incorrect voltage supply.**

- ▶ Only connect the device to voltage supplies which correspond with the electrical requirements on the name plate.
- ▶ Only use sockets with a protective earth (PE) conductor and a suitable mains/power cord.



**WARNING! Electric shock due to damage to device or mains/power cord.**

- ▶ Only switch on the device if the device and the mains/power cord are undamaged.
- ▶ Only use devices that have been properly installed or repaired.
- ▶ In case of danger, disconnect the device from the mains supply. Disconnect the mains/power plug from the device or the earth/grounded socket. Use the isolating device intended for this purpose (e.g., the emergency switch in the laboratory).



**NOTICE! Damage to electronic components due to condensation.**

Condensate can form in the device after it has been moved from a cool environment to a warmer environment.

- ▶ After installing the device, wait for at least 6 h. Only then connect the device to the mains/power line.
- 

#### 4.3.1 Connecting the device to the voltage supply

Prerequisites

- Mains/power connection in accordance with the name plate.

1. Connect the mains/power cord at the rear of the device.
2. Fasten the safety clamp.

If the device is moved, the mains/power cord cannot be pulled out of the device.

### 4.3.2 Remote alarm interface

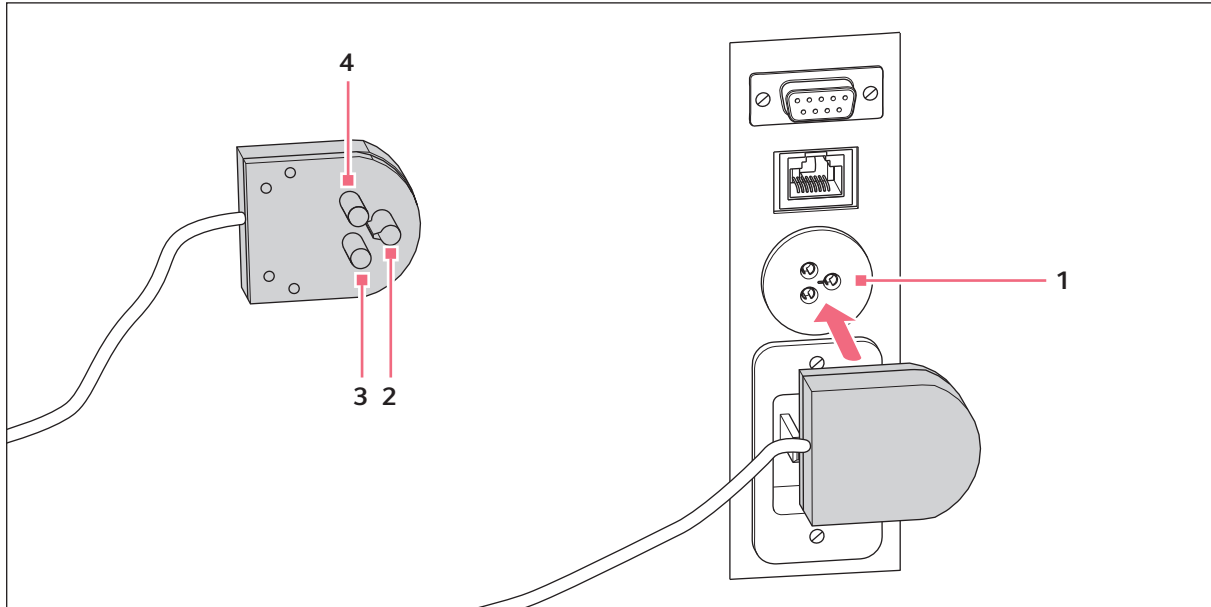

Fig. 4-2: Plug and remote alarm interface

- |   |  |
|---|--|
| <b>1 Remote alarm interface</b><br>Connection to the building management system | <b>3 Pin 2</b><br>No alarm (pin assignment: pin 1 – pin 2) |
| <b>2 Pin 1</b><br>PE conductor  | <b>4 Pin 3</b><br>Alarm (pin assignment: pin 1 – pin 3)    |

You can connect the device to a building management system via the remote alarm interface. The device transmits alarms to the building management system, e.g., in the event of a mains/power outage or temperature rise. Contact your local Eppendorf partner for more information.

The plug required for connecting the remote alarm interface is included in the delivery package. Connections must have a double or reinforced insulation, according to DIN EN 61010-1.

### 4.3.3 RS-485 interface

You can connect the device to a building management system via the RS-485 interface. The device transmits alarms to the building management system, e.g., in the event of a mains/power outage or temperature rise.

You can connect the device to external systems via the RS-485 interface.

Contact your local Eppendorf partner for more information.

Connections must have a double or reinforced insulation, according to DIN EN 61010-1.

#### 4.3.4 Ethernet interface

The device is equipped with an Ethernet interface. This allows you to connect the device to an external monitoring system, e.g., a building management system or a laboratory management system. The interface provides data about the current status and the identity of the device. Contact your local Eppendorf partner for more technical information.

Connections must have a double or reinforced insulation, according to DIN EN 61010-1.

#### 4.4 Connecting the device to the water supply

The owner is responsible for connecting the device to the water supply. The device must be connected according to local standards and regulations.



**NOTICE! Damage due to too high cooling water temperature.**

The cooling water temperature must correspond to the specification in the technical data of each device.

Cooling water coming from a freezer is hot. This water cannot be used for cooling of other devices.

- ▶ Never connect ULT freezer to a water pipe in series.
- 

You can connect several devices to a water supply in parallel.

The owner has to make sure that the following prerequisites are met:

- Connection to the water supply corresponds to the technical data.
- The water quality corresponds to the technical data.
- The water pressure has been checked. The water pressure corresponds to the technical data.
- The water control valve is adjusted.
- The chiller has the required capacity.

Tools and auxiliary equipment

- Strainer with mesh width: 0.25 mm (60 mesh)
- There is a pressure control valve for each ULT freezer

1. Insert the strainer into the inlet pipe.
2. Mount a pressure control valve upstream of each device to check the water pressure.

### Connecting the device to a water supply without recirculation

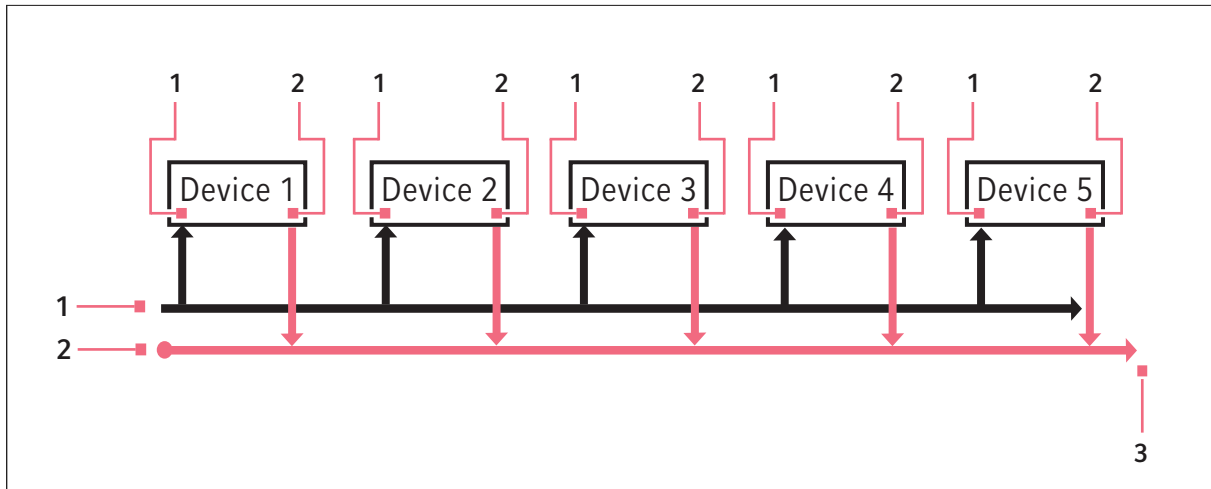

1 Inlet

3 Drain

2 Outlet

3. Connect the device to the water supply as shown in the drawing.

### Connecting the device to a water supply with a chiller

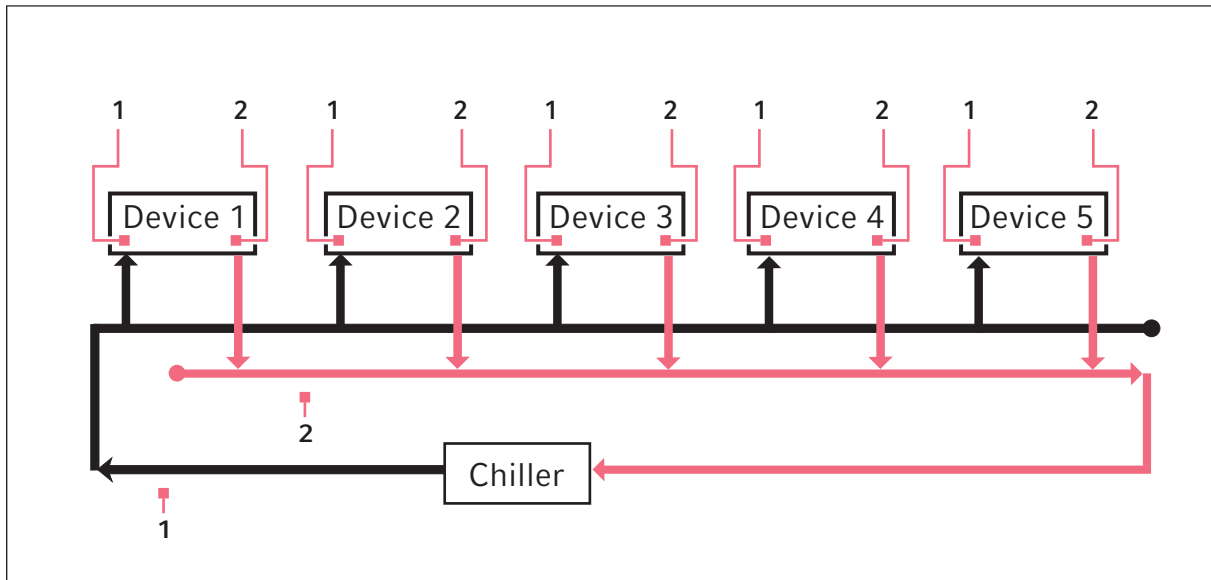

1 Inlet

2 Outlet

4. Connect the device to the water supply as shown in the drawing.

The temperature at the water outlet is a maximum of 25 °C.

#### 4.4.1 Water flow rate

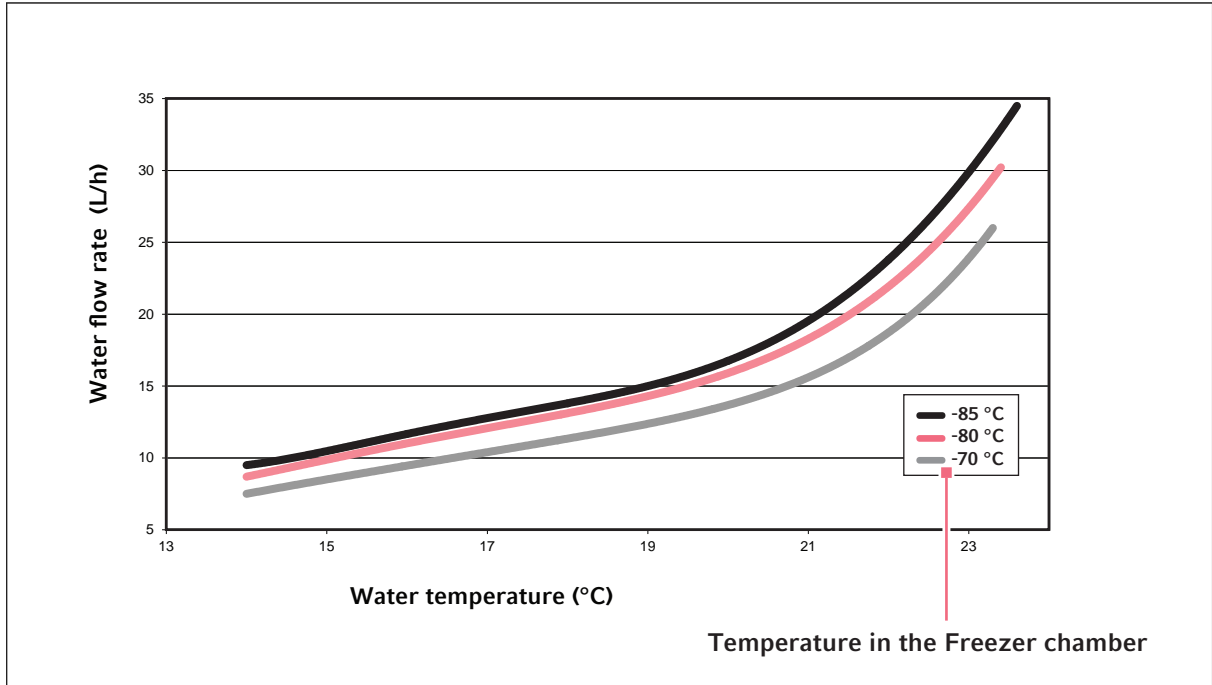

Fig. 4-3: Water flow rate with the water control valve set to factory settings

With the factory settings, the device is configured so that the refrigerant leaves the condenser at a temperature of 25 °C. At this temperature, the device can best balance the water temperature and the requirements of energy efficiency.

The temperature at which the refrigerant leaves the condenser depends on the water flow rate through the condenser. The water flow rate is adjusted with the water regulating valve.

**Installation**

CryoCube® F740i  
English (EN)

## **4.5 Switching on the device**

### **4.5.1 Enabling the safety circuit**

The safety circuit is operated by a battery. In the event of a mains/power outage, the battery will supply the control panel and the alarm for 48 hours.

Tools and auxiliary equipment

- Key for the switch locking plate

Prerequisites

- The device has been installed and connected according to the operating manual.
- The device has been acclimatized for at least 6 h.

1. Unlock the switch locking plate and remove the cover.
2. Switch on the battery switch.

The safety circuit is enabled.

- An alarm is triggered in the event of a mains/power outage.
- During a mains/power outage, the power supply to the touch screen is ensured.
- The software settings are saved in the event of a mains/power outage.
- The battery is charged via the power supply circuit. It takes about 24 hours to fully charge the battery.

3. Fit the cover and lock it.

### **4.5.2 Switching on the mains/power supply**

Tools and auxiliary equipment

- Key for the switch locking plate

Prerequisites

- The device has been installed and connected according to the operating manual.
- The device has been acclimatized for at least 6 h.

1. Unlock the switch locking plate and remove the cover.
2. Switch on the mains/power switch.
  - The software is shown on the display.
  - The compressor starts running after a short time delay.

3. Install the cover and lock it.



## 5 Operation

### 5.1 Basic device settings

#### 5.1.1 Setting the set temperature of the interior of the device

Set the set temperature of the interior of the device.

Prerequisites

- The device is ready for operation.
  - The home screen appears on the touch screen.
- ▶ Setting the set temperature of the interior (see *Home screen on p. 37*).

#### 5.1.2 Setting warning limits and alarm limits

To determine when a warning or an alarm should be triggered, you can define warning limits and alarm limits. If a limit is exceeded, a warning or an alarm is triggered. Warning messages and alarm messages are shown in the information bar.

You can monitor the following parameters:

- Actual temperature in the interior
- Ambient temperature
- Time how long the outer door is open

Prerequisites

- The device is ready for operation.
- The home screen appears on the touch screen.
- If a user management is used, the administrator must be logged in.

1. Tap the *Menu > Alarms* buttons.
2. Set the alarm limits of the device (see *Alarms on p. 44*).

#### 5.1.3 Setting the alarm delay

You can set an alarm delay. This prevents the triggering of an alarm if the temperature in the interior briefly exceeds the high alarm, e.g., due to the outer door remaining open for longer period of time. If the temperature is above the alarm limit after the delay time has elapsed, the device will trigger an alarm.

1. Press the *Menu* button.
2. Select *Alarm delays*.
  - *Acoustic alarm delay*: Delay time for the acoustic alarm (default setting 30 minutes).
  - *Remote alarm delay*: Delay time for the alarm to the building management system (default setting 30 minutes).
3. Set the delay time.

#### 5.1.4 Enabling the user management

- ▶ To regulate and document access to the device, you can enable the user management (see *User administration on p. 61*).

## 5.2 Loading the device

---



**CAUTION! Risk of crushing your fingers when closing the outer door.**

- ▶ Do not place your fingers between the device and the outer door.
- ▶ Do not touch the peg and the covers of the door lock when closing the outer door.



**CAUTION! Risk of head injuries due to open inner door.**

If the upper inner doors are open, you may bump your head against the inner doors.

- ▶ Only open one inner door at a time.
  - ▶ Immediately close the inner door after completing your work in the inner compartment.
- 

### Prerequisites

- Racks and accessories have been placed in the compartments.
- The device has reached the set temperature.

1. Open the outer door.
2. Open the inner door of the compartment in which the samples are stored.
3. Sort the samples in the device.

Information on the maximum carrying capacity for each inner shelf can be found in the technical data.

4. Close the inner door.
5. Close the outer door.

## 5.3 Switching off the device

---



**WARNING! Electric shock due to damage to device or mains/power cord.**

- ▶ Only switch on the device if the device and the mains/power cord are undamaged.
  - ▶ Only use devices that have been properly installed or repaired.
  - ▶ In case of danger, disconnect the device from the mains supply. Disconnect the mains/power plug from the device or the earth/grounded socket. Use the isolating device intended for this purpose (e.g., the emergency switch in the laboratory).
- 

### 5.3.1 Disabling the safety circuit

Tools and auxiliary equipment

- Key for the switch locking plate

1. Unlock the switch locking plate and remove the cover.
2. Switch off the battery switch.

The safety circuit is disabled.

- No alarm is triggered in the event of a mains/power outage.
- During a mains/power outage, the supply of power to the touch screen is not ensured.
- The software settings are not saved in the event of a mains/power outage.
- The battery does not charge.

### 5.3.2 Disconnecting the device from the voltage supply

Tools and auxiliary equipment

- Key for the switch locking plate

1. Unlock the switch locking plate and remove the cover.
2. Switch off the mains/power switch.



## 6 Overview of operating controls

### 6.1 Operating the user interface

**i** The touch screen is designed to be operated with your fingers only without the need for tools. Laboratory gloves made of nitrile or latex can be worn. Alternatively, a stylus can be used, for example, when thick gloves need to be worn in the laboratory.

**i** If liquid comes into contact with the touch screen, the functions displayed on the touch screen may be triggered.

- ▶ Do not drop any liquids onto the touch screen.
- ▶ Do not spill any liquids onto the touch screen.

#### 6.1.1 Home screen

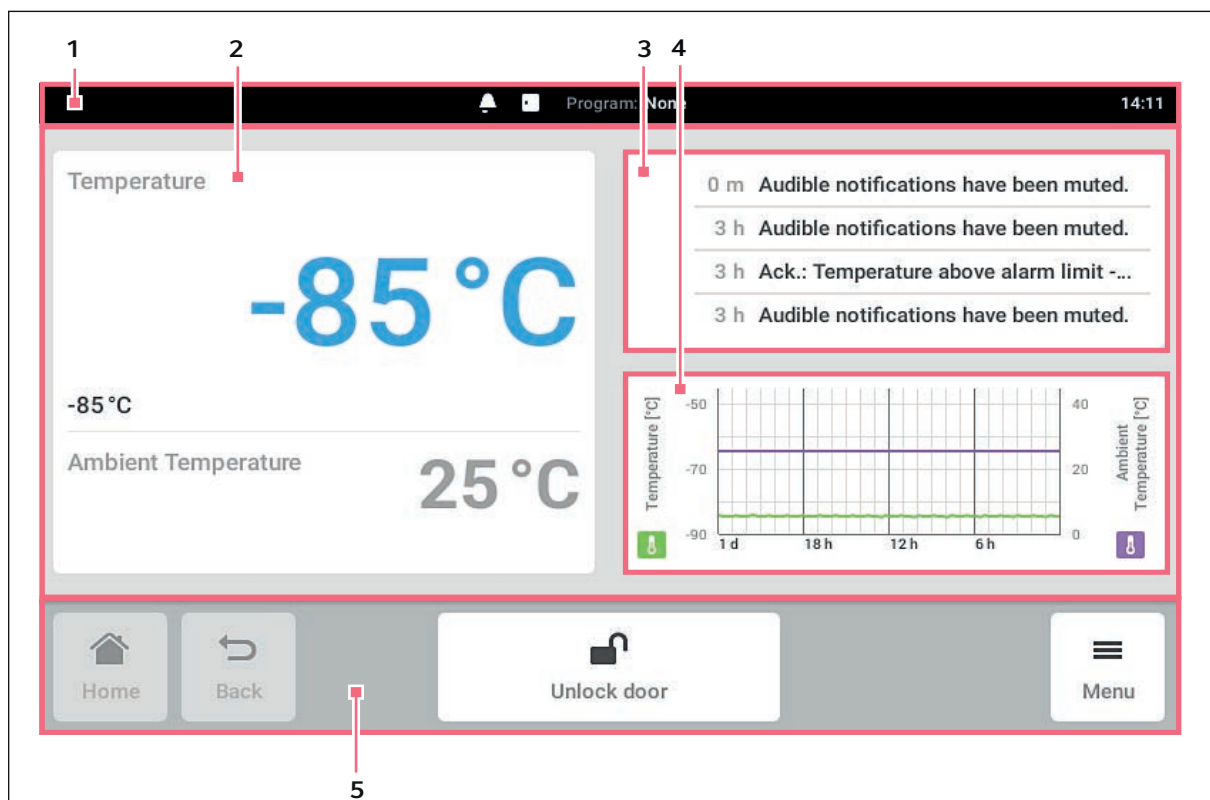

Fig. 6-1: Home screen

#### 1 Status bar

Information about the user, time, device status

#### 2 Function area

Display of the set temperature, actual temperature and ambient temperature

#### 3 Events

Log

#### 4 Chart

Chart of the actual temperature in the interior and the ambient temperature

#### 5 Toolbar

Buttons for navigation and operation of the device

### 6.1.2 Function area

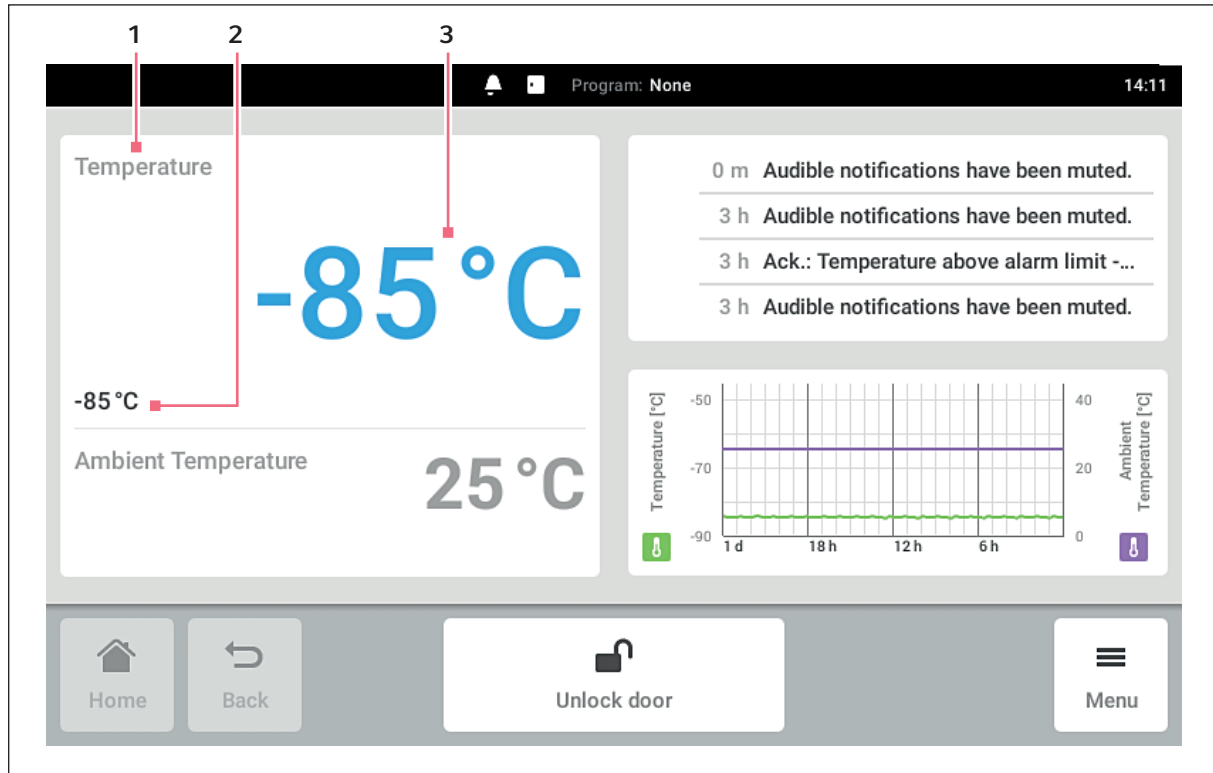

Fig. 6-2: Function area

#### 1 Name of the active function

#### 2 Set value of the active function

The set value of an active function is displayed in small black numbers.

#### 3 Actual value of the active function

The actual value of an active function is displayed in large blue numbers.

### 6.1.3 Toolbar

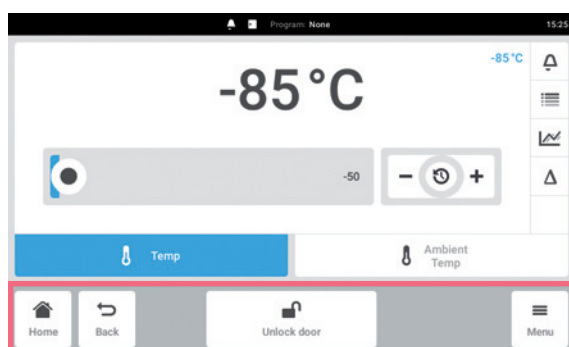

Fig. 6-3: Toolbar

- ▶ Tap the *Home* button.  
The home screen is displayed.
- ▶ Tap the *Back* button.  
The previous window is displayed.
- ▶ Tap the *Menu* button.  
The menu appears. With the menu items, functions such as *Settings*, *Alarms* or *Event Log* can be called up.

### 6.1.4 Information bar

If messages are present, the information bar appears instead of the status bar. The information bar displays alarm messages and warning messages.

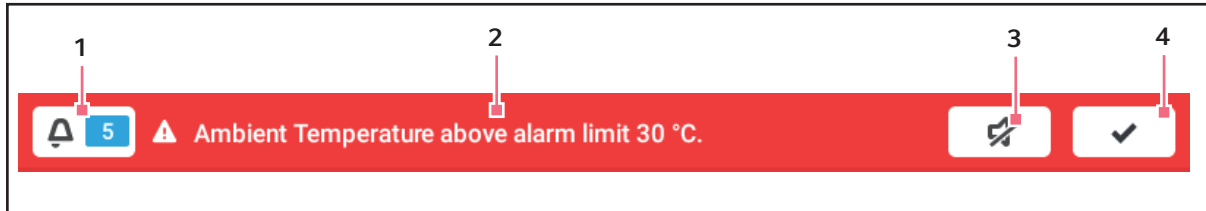

Fig. 6-4: Information bar

#### 1 Number of unacknowledged messages

#### 2 Current message

Red information bar: Unacknowledged alarm messages.

Yellow information bar: Unacknowledged warning messages.

#### 3 Audible alarm

Temporarily disables the audible alarm.

#### 4 Acknowledging the current message

When the current message has been acknowledged, it is deleted from the information bar.

When all messages have been acknowledged, the information bar disappears.

### Editing the information bar

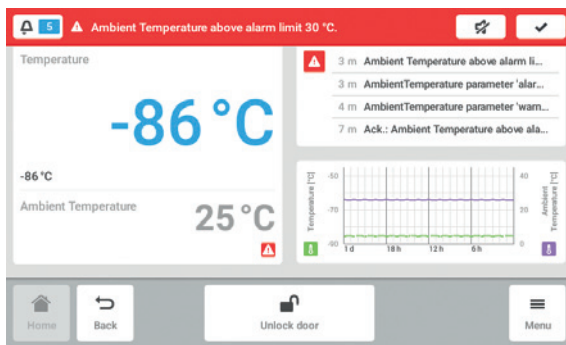

- ▶ To display the log, tap the number next to the bell symbol.
- ▶ To temporarily disable the audible alarm, tap the *mute* symbol.
- ▶ To confirm the current message, tap the checkmark symbol.

### Editing the message

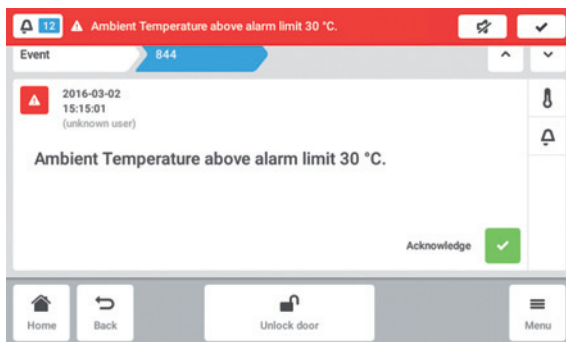

- ▶ To call up the current message, tap the information bar. The message appears in the log.
- ▶ To acknowledge the message, tap the *Acknowledge* button.
- ▶ To change the alarm limits, tap the *Alarm* (bell symbol) symbol.
- ▶ To change the set value of the function, tap the button above the *Alarm* symbol.

## Overview of operating controls

CryoCube® F740i  
English (EN)

### 6.1.5 Selecting the function



- ▶ Tap the function in the function area.  
The window for setting the set value appears.

### 6.1.6 Setting the set value

Setting the set value with the slider



- ▶ Tap the slider and drag it to the right or to the left.  
The set value changes.

Changing the set value gradually with the fine adjustment

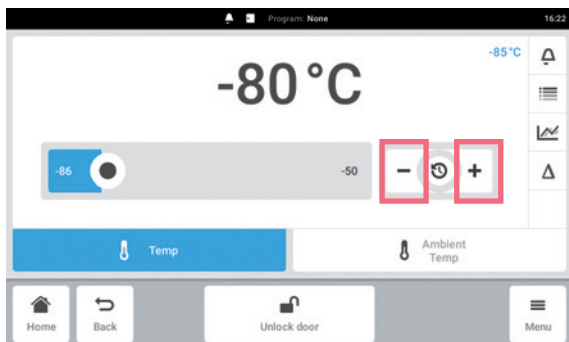

- ▶ Tap the + button.  
The set value is gradually increased.
- ▶ Tap the - button.  
The set value is gradually decreased.



### Selecting the last used set value

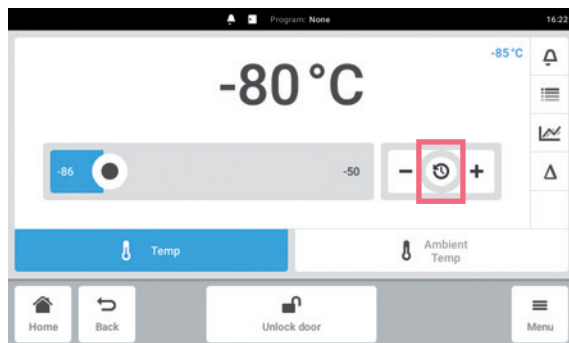

1. Tap into the center of the fine adjustment.  
A list with the last used set values is displayed.
2. Select the set value.

### Entering the set value with the number pad

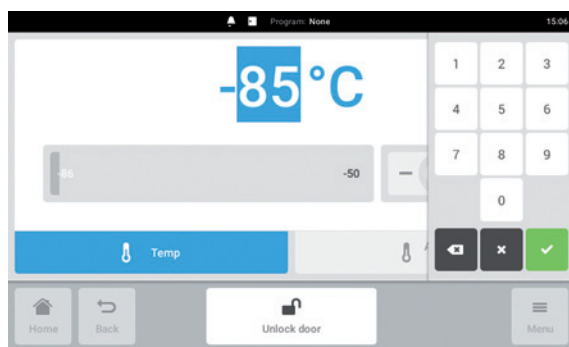

1. Tap the set value.  
The number pad appears.
2. Enter the new set value.
3. Confirm your entry.  
The entry is completed. The number pad disappears.

### 6.1.7 Switching between the functions

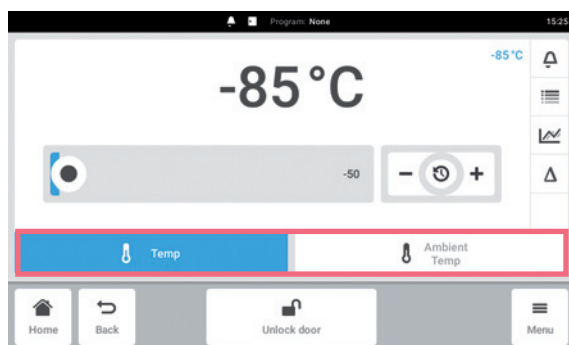

- ▶ To switch to another function, tap on the symbol of the function.  
The active function is highlighted in blue.



## 7 Menu area

The *Menu* area contains all the software settings.

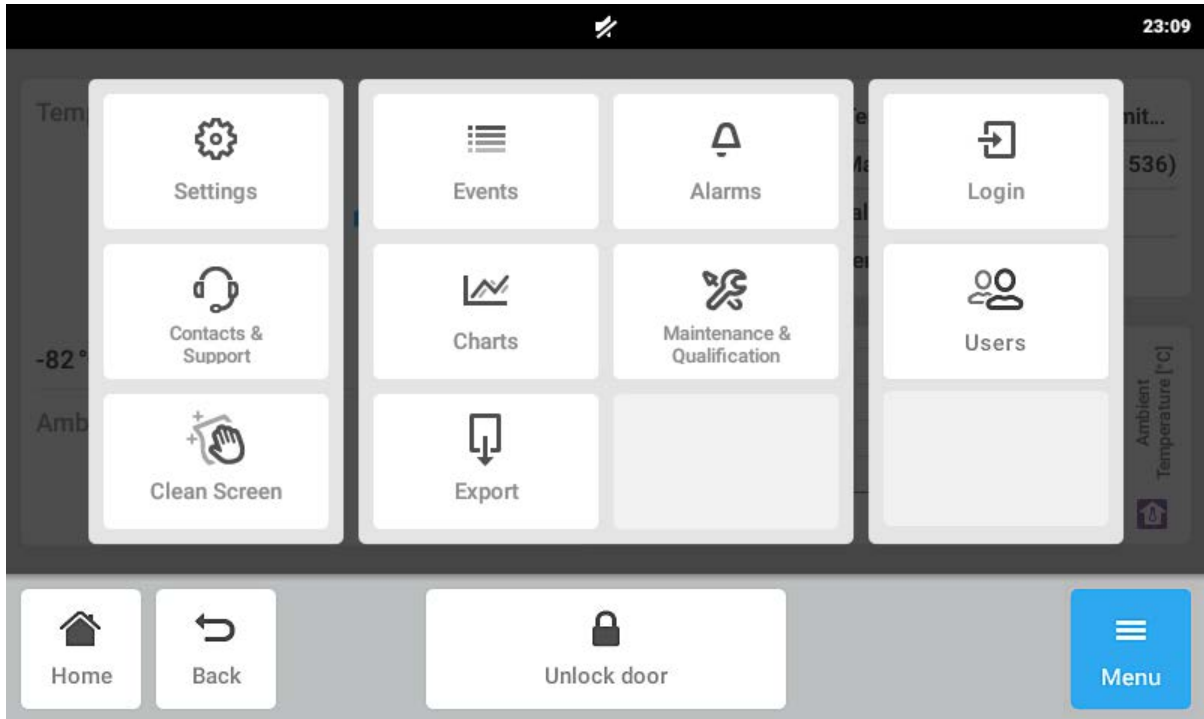

Fig. 7-1: Menu items

## 7.1 Alarms

You can set alarms and alarm limits for the device.

The device has three alarms:

- Alarm if the temperature in the interior exceeds the alarm limits.
- Alarm if the ambient temperature exceeds the alarm limits.
- Alarm if the outer door has been open for too long.

### 7.1.1 Setting alarms and alarm limits

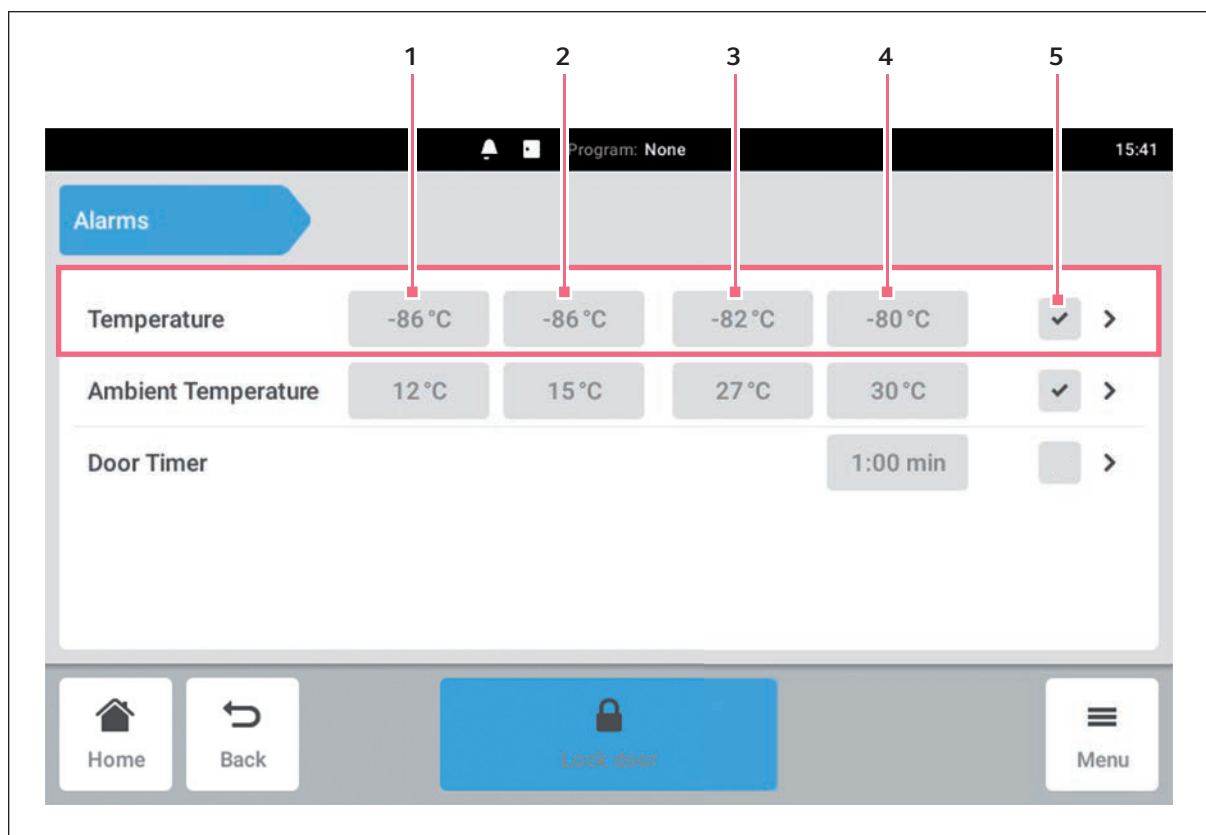

Fig. 7-2: Alarm overview for all alarms of the device

- |                       |                                 |
|-----------------------|---------------------------------|
| <b>1 Low alarm</b>    | <b>4 High alarm</b>             |
| <b>2 Low warning</b>  | <b>5 Alarm enabled/disabled</b> |
| <b>3 High warning</b> |                                 |

1. To access the device alarm overview, tap the *Menu > Alarms* button.  
 A window containing all the device alarms, the warning limits and the alarm limits appears.
2. To call up an alarm, tap the corresponding line.  
 The overview window for this alarm appears.

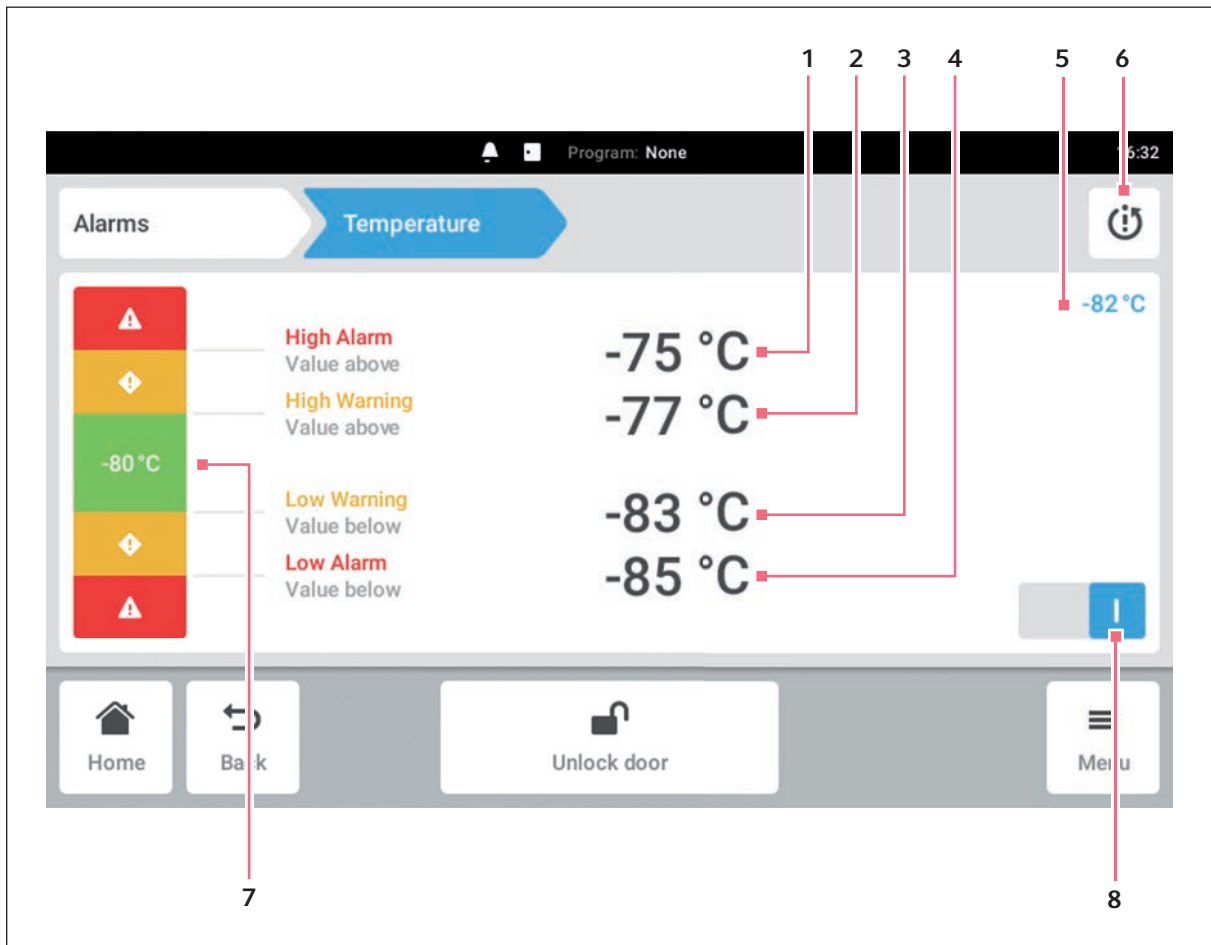
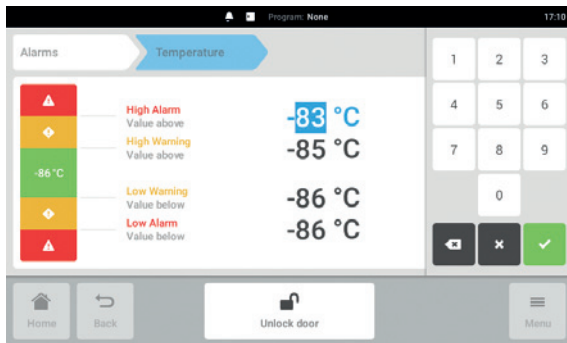

Fig. 7-3: Alarm overview for a function

- |                       |   |
|-----------------------|---|
| <b>1 High alarm</b>   | <b>5 Actual value of the function</b>   |
| <b>2 High warning</b> | <b>6 Factory settings symbol</b><br>Resets the warning limits and alarm limits to the factory settings. |
| <b>3 Low warning</b>  | <b>7 Set value of the function</b>  |
| <b>4 Low alarm</b>    | <b>8 Enable/disable the alarm.</b>  |



3. To change an alarm limit, tap the alarm limit. The number pad appears.
4. Enter the new alarm limit.
5. Confirm your entry. The entered alarm limit appears on the touch screen.

### 7.1.2 Active alarm

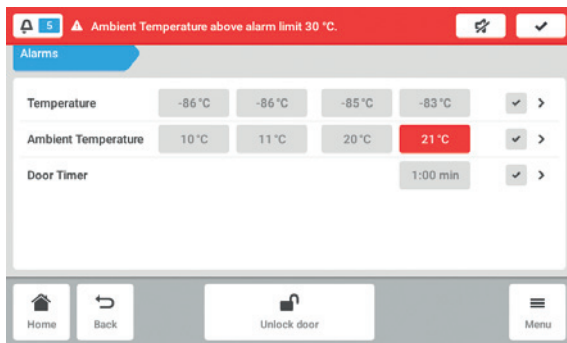

Fig. 7-4: Alarm overview of the device with the active alarm

If an alarm is active, the exceeded alarm limit is highlighted in red in the alarm overview. The alarm appears in the information bar.

## 7.2 Charts

The chart shows two functions on two y-axes. The time is shown on the x-axis.



Fig. 7-5: Diagram

- |   |   |
|---|---|
| <p><b>1 Function symbol</b><br/>Selects the function to be shown in the chart.</p> <p><b>2 Time span symbol</b><br/>Selects the time span to be shown in the chart.</p> | <p><b>3 Name of the function shown.</b></p> <p><b>4 Export button</b><br/>Exports the data.</p> |
|---|---|

### Calling up the chart

- ▶ Tap the *Menu > Charts* button.

### Selecting functions

- ▶ To select which function is shown, tap the **(1)** button.  
A window with two lines appears.

## Menu area

### CryoCube® F740i

#### English (EN)

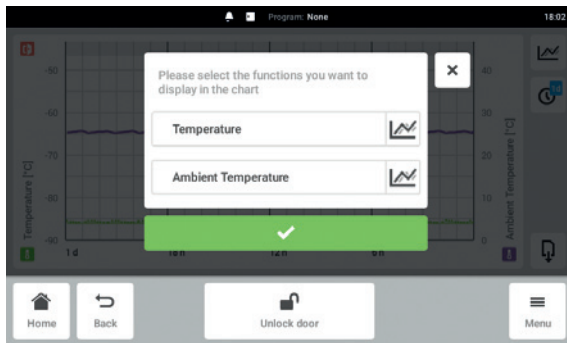

- ▶ To select the functions for the left y-axis, tap the upper line.
  - ▶ To select the functions for the right y-axis, tap the lower line.
- A window with the available functions appears.

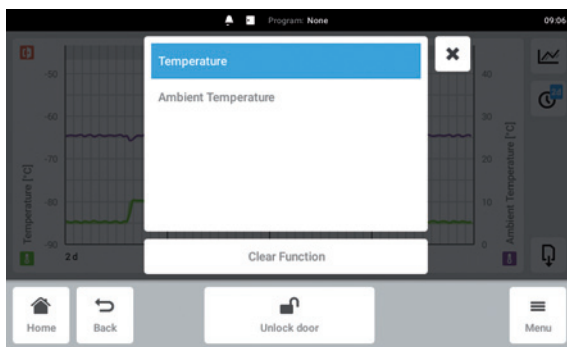

- ▶ Select the function.
- The function appears in the tapped line.

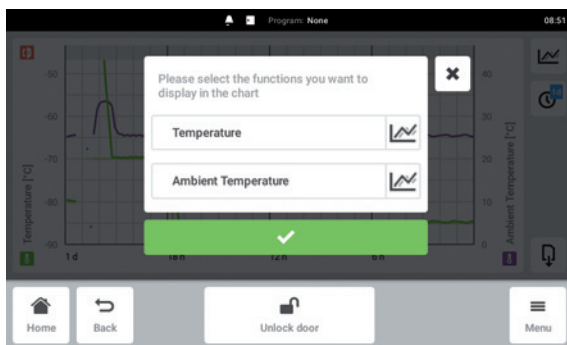

- ▶ Confirm your selection.
- The functions appear in the chart.

## Selecting the time span

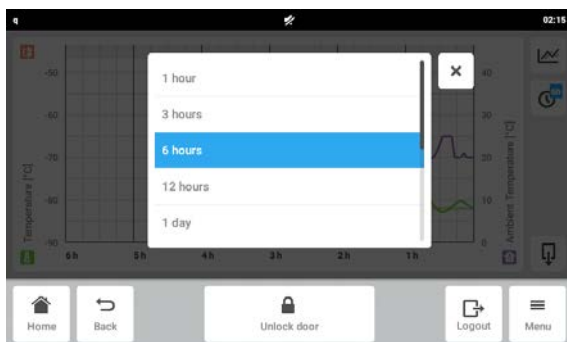

- ▶ To select the time span, tap the **(2)** button.
  - ▶ Select the time span.
- The time span appears on the x-axis.



### Displaying values from the chart

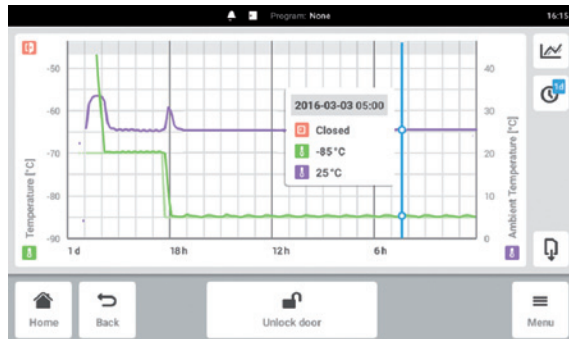

- ▶ To display numerical values from the chart, select a defined time.
- ▶ Tap the corresponding point in the chart. The functions are displayed in a separate window.

### Exporting the chart

- ▶ To export the data from the chart, tap the Export button (see *Export on p. 59*).

## 7.3 Events

This area contains messages and alarms with the corresponding time and, if applicable, the user. You can filter and export *events*.

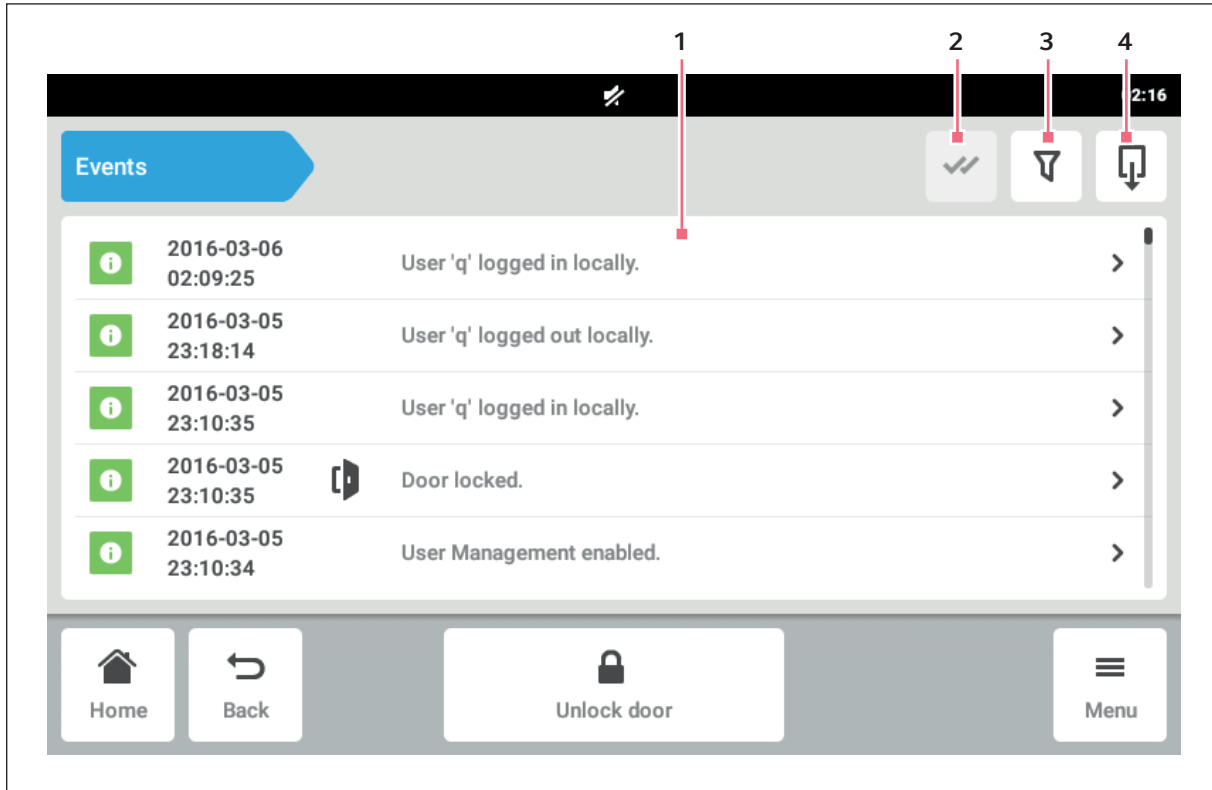

Fig. 7-6: *Events* window

- |  |   |
|--|---|
| <p><b>1 Messages of alarms and events</b></p> <p><b>2 Acknowledgment symbol</b><br/>Confirms all alarms.</p> | <p><b>3 Filter symbol</b><br/>Calls up the filter.<br/>The symbol is highlighted in blue when the log is filtered.</p> <p><b>4 Export symbol</b><br/>Exports the log.</p> |
|--|---|

### Calling *Events*

- ▶ Tap the *Menu* > *Events* button.

## Filtering events

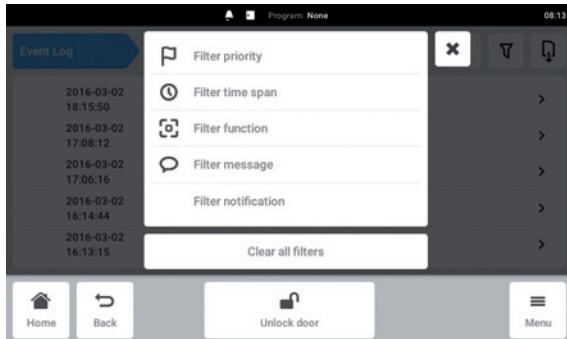

- ▶ Tap the Filter button.
- ▶ Select the filter.  
If a filter is enabled, a checkmark appears next to the filter. The filter symbol is highlighted in blue .
- ▶ To disable all the filters, tap the *Clear all filters* button.

## Exporting events

- ▶ To export events, tap the Export button (see *Export on p. 59*).

## 7.4 Settings

This area provides you with information about the device. You can make device settings and enable the user management.

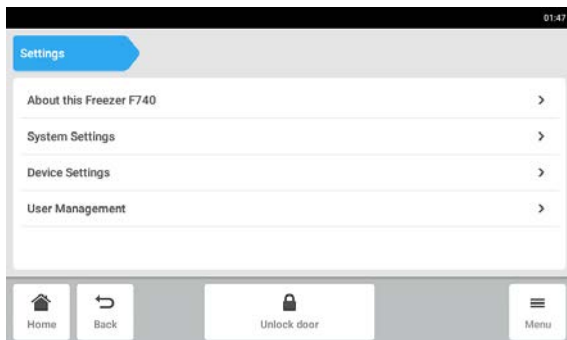

- ▶ The following settings are available:
  - *About this Freezer*: View information about the device and licenses.
  - *System Settings*: Configure the date, time and network.
  - *Device Settings*: Configure the alarm and display.
  - *User Management*: Create user management (see *User administration on p. 61*).

### 7.4.1 About this Freezer menu item

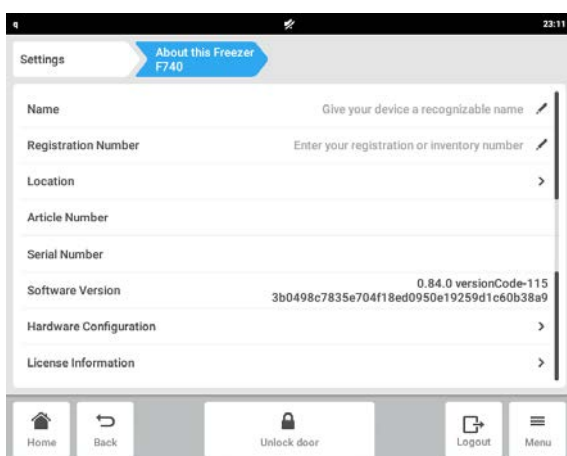

- ▶ Tap the *Menu > Settings > About this Freezer* menu item.  
The following fields are available:
  - *Name*: Enter the device name.
  - *Registration Number*: Enter the inventory number of the device.
  - *Location*: Enter the location of the device.
  - *Article number*: The article number of the model
  - *Serial number*: The serial number of the device, see the name plate.
  - *Software Version*: User software version
  - *Hardware Configuration*: View information about optional extensions.
  - *License Information*: View information about licenses.

### *Location* - entering the location of the device

- ▶ Enter information about the location of the device.

### 7.4.2 *System* menu item

- ▶ Tap the *Menu > Settings > System* item. The following settings are available:
  - *Date & Time*: Set the date, time and time zone.
  - *Network*: Set the parameters for network operation.

## Data & Time – setting the date and time automatically

### Prerequisites

- The device is connected to the network.
- A time server is available.



Changing the date, time or time zone may temporarily affect the appearance of the chart. The log may be incorrectly sorted.

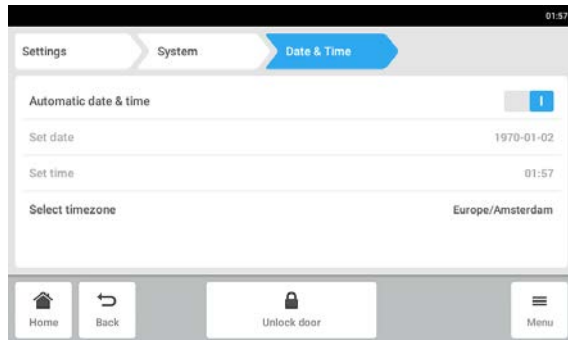

- ▶ Tap the *Menu > Settings > System > Date & Time >* buttons.
- ▶ Switch on the *Automatic date & time* switch.
- ▶ Tap the *Select timezone* menu item.

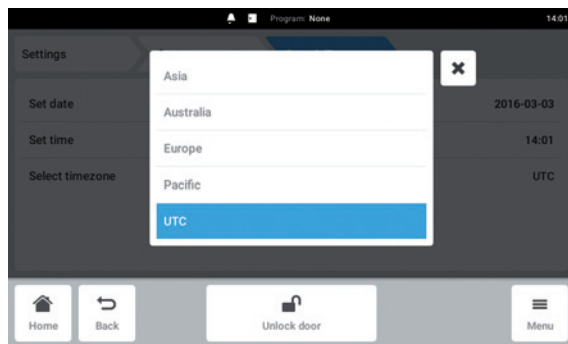

- ▶ Select the continent.

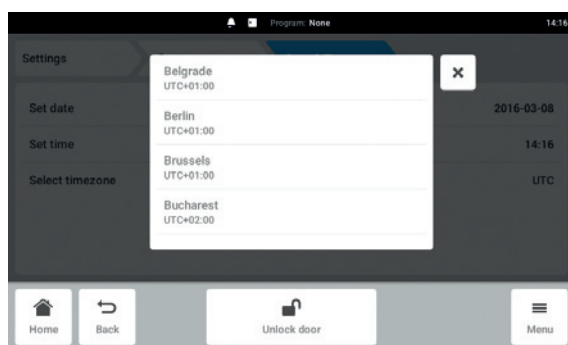

- ▶ Select the time zone.
- ▶ Close the selection.  
The *Date & Time* menu appears.

### Data & Time – setting the date and time manually



Changing the date, time or time zone may temporarily affect the appearance of the chart. The log may be incorrectly sorted.

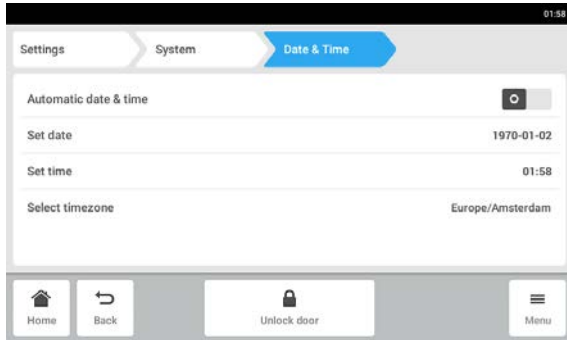

- ▶ Tap the *Menu > Settings > System > Date & Time >* buttons.
- ▶ Switch off the *Automatic date & time* switch. The *Set date* and *Set time* menu items become active.
- ▶ Tap the *Set date* menu item.

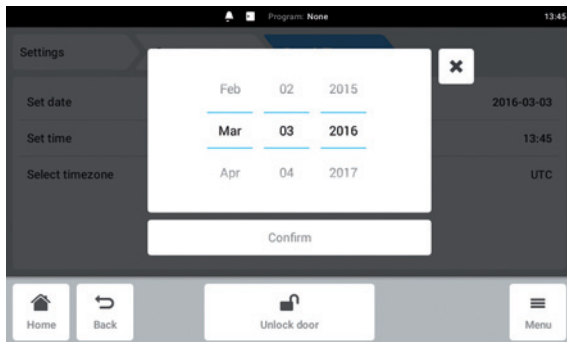

- ▶ Set the current date.
- ▶ Tap the *Confirm* button. The date is saved. The *Date & Time* menu appears.

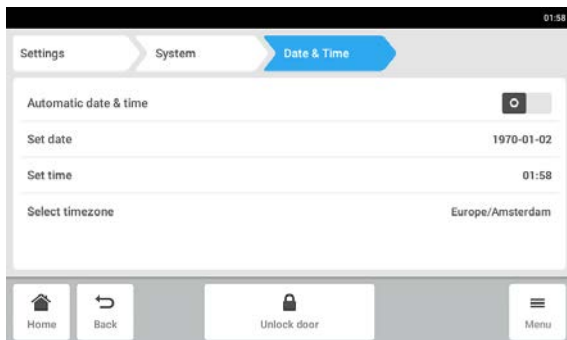

- ▶ Tap the *Set time* menu item.

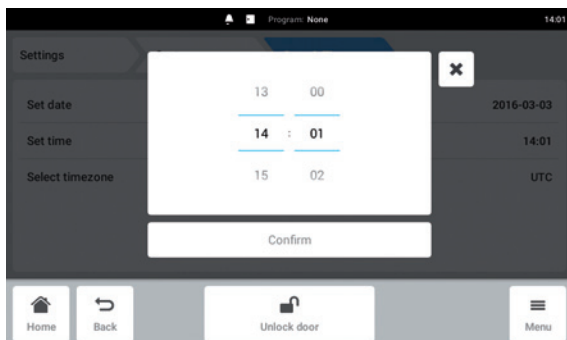

- ▶ Set the time.
- ▶ Tap the *Confirm* button. The time is saved. The *Date & Time* menu appears.

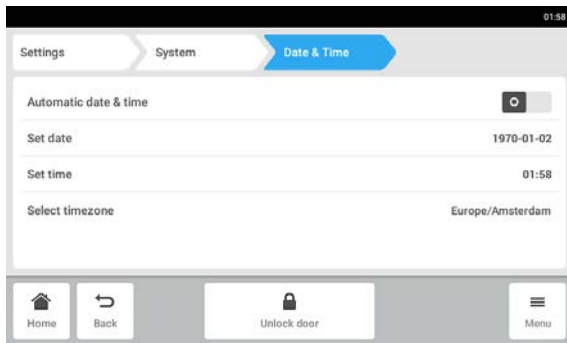

- ▶ Tap the *Select timezone* menu item.

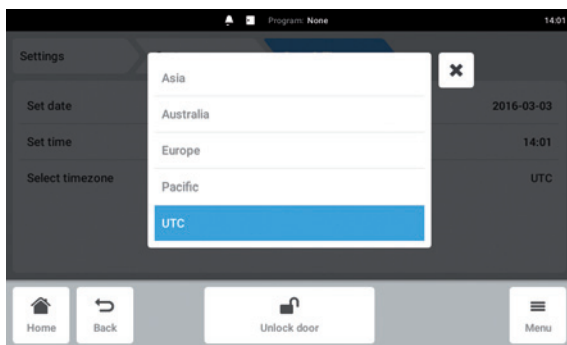

- ▶ Select the continent.

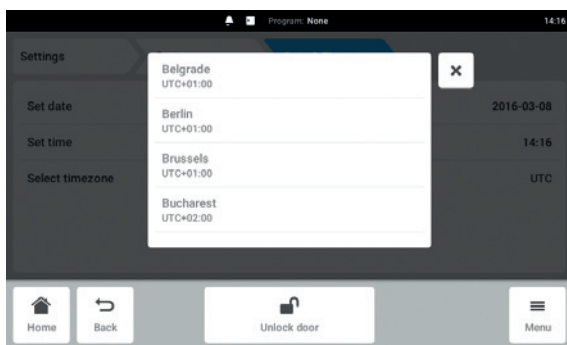

- ▶ Select the time zone.
- ▶ Close the selection.  
The *Date & Time* menu appears.

## Network

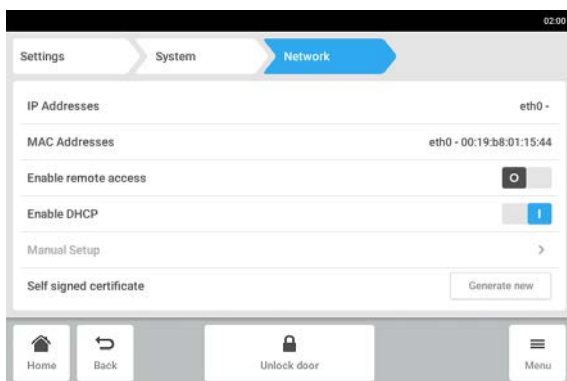

- ▶ Tap the *Menu > Settings > System > Network* buttons.  
The following settings are available:
  - *IP Adresses*: Current IP address of the device
  - *MAC Adresses*: Address by which the device can be uniquely identified in the network
  - *Enable remote access*: The device allows communication with external software.
  - *Enable DHCP*: The device uses an IP address that was assigned by a DHCP server.
  - *Manual Setup*: Enter the network settings manually. Active when the *Enable DHCP* switch is switched off.

### Network – entering the network settings manually

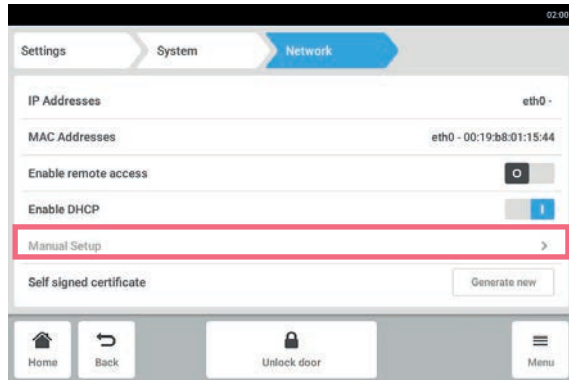

- ▶ Tap the *Menu > Settings > System > Network > Manual Setup* menu item.

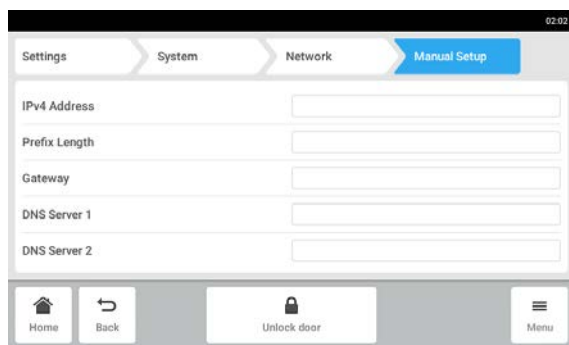

- ▶ To enter a value, tap the edit box. The number pad appears.
- ▶ Enter the value.
- ▶ Confirm your entry.
- ▶ Tap the *Back* button. The data is saved. The window for the network settings appears.

### 7.4.3 Device menu item

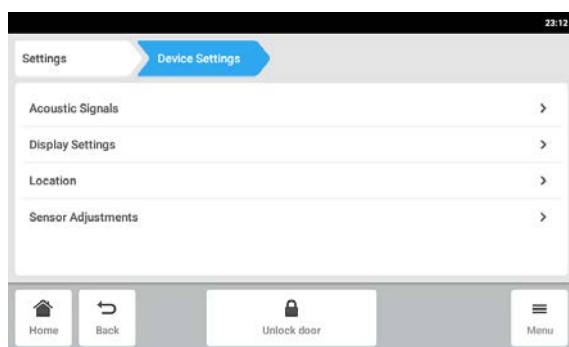

- ▶ Tap the *Menu > Device Settings > Device* entry. The following settings are available:
  - *Acoustic Signals*: Set the audible alarm.
  - *Display Settings*: Set the brightness, power saving mode and timeout of the display.
  - *Location*: Enter the location of the device.
  - *Sensor Adjustment*: Enter the offset for the interior sensor.



### Acoustic Signals – setting the audible alarm

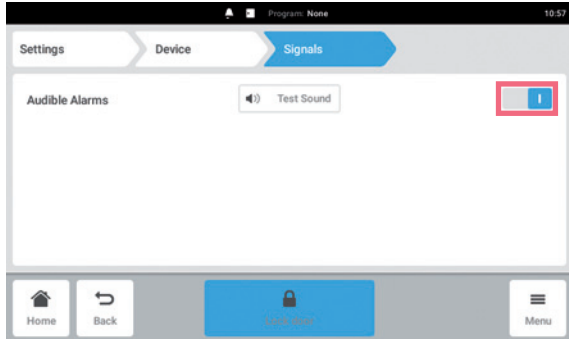

- ▶ Tap the *Menu > Settings > Device > Acoustic Signals* menu line.
- ▶ To enable or disable the audible alarm, tap the *O I* switch.
- ▶ To test the audible alarm, tap the *Test Sound* button.

### Display settings – setting the touch screen

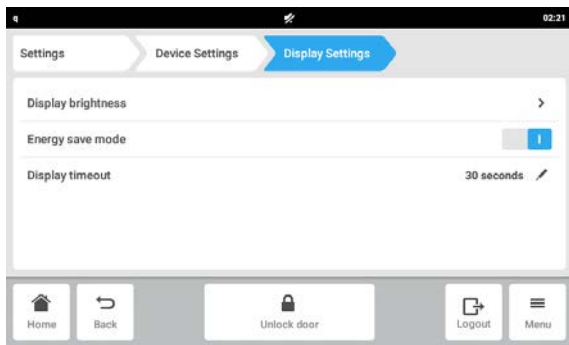

- ▶ Tap the *Menu > Settings > Device > Display settings* menu line.  
The following settings are available:
  - Display brightness
  - Display power saving mode
  - Time after which the display is dimmed
- ▶ To enable or disable the energy save mode, tap the *O I* button.
- ▶ Set after which time the display will be dimmed
- ▶ Configure the *Display timeout* und *Display brightness* settings accordingly.

### Location – the location of the device

- ▶ Enter the location of the device, (see p. 51)

### Sensor Adjustment – offset for the interior sensor

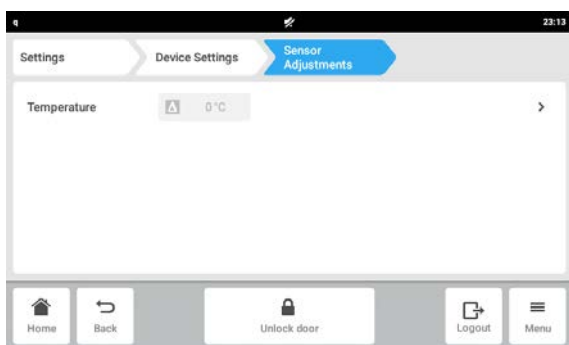

- ▶ Tap the *Menu > Settings > Device > Sensor Adjustment* menu line.
- ▶ Enter and confirm the value.

## 7.5 Contact and Support

Information about your local contact persons can be found here.

## 7.6 *Clean Screen*

### 7.6.1 Cleaning the touch screen

#### Locking the touch screen

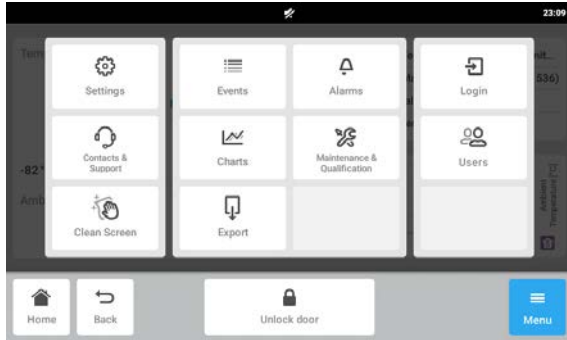

1. Tap the *Menu > Clean Screen* button.  
 The touch screen is locked and can be cleaned.

#### Unlocking the touch screen

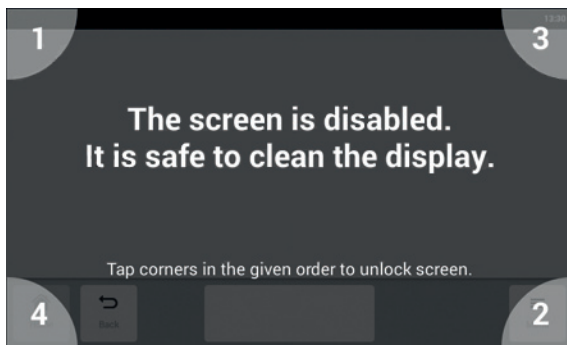

2. Tap the corners of the touch screen in the numbered sequence.  
 The touch screen is unlocked. The previous screen is displayed.

## 7.7 Export

You can export charts, logs and data for service to a USB storage medium.

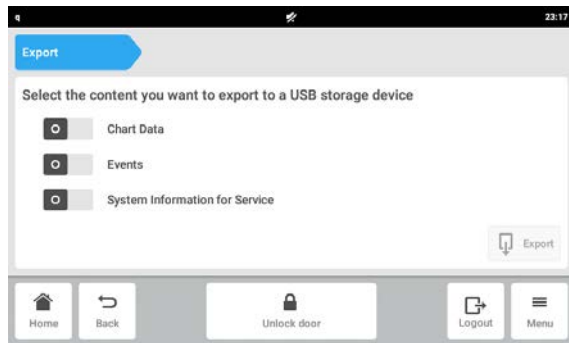

1. Connect a USB storage medium.
2. Tap the *Menu > Export* menu items.
3. Use the sliders to select which data to export. Data shown in gray cannot be exported.
4. Tap the *Export* button.

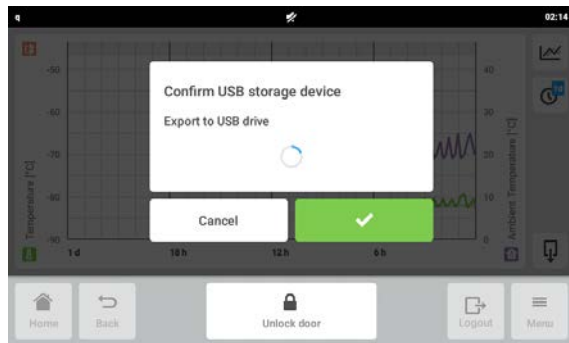

5. Confirm the connected USB storage medium.

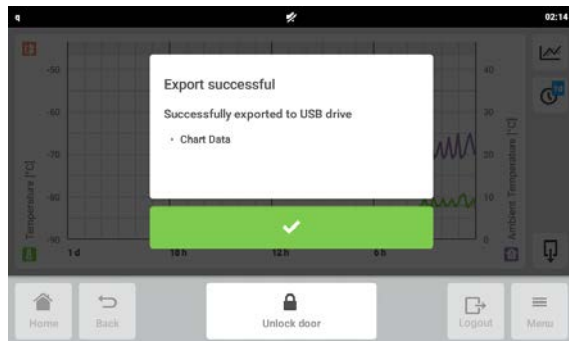

6. Confirm the export.
7. Remove the USB storage medium.



## 8 User administration

### 8.1 User groups

The following user groups are available in the software.

Tasks	Administrator	User level 1 (Restricted user)	User level 2 (User)
Opening the outer door	x	x	x
Changing settings	x	-	-
Acknowledging an alarm	x	-	x
Acknowledging warnings	x	x	x
Managing user accounts	all	own	own
Defining settings in the user management	x	-	-

## 8.2 User management

### 8.2.1 Setting up the user management and creating the first administrator



**NOTICE! Data loss due to loss of the administrator password.**

The administrator can only change his password or PIN with his access data. If the administrator's access data is lost, no changes will be possible in the user management and system settings.

In this case, the device will have to be reset to the factory settings by an authorized service technician. All the user accounts and the data and settings stored on the device will be deleted.

- ▶ Create a second user account with administrator rights.
- ▶ Keep the administrator password secure.

#### Prerequisites

- The device is ready for operation.
- The home screen appears on the touch screen.

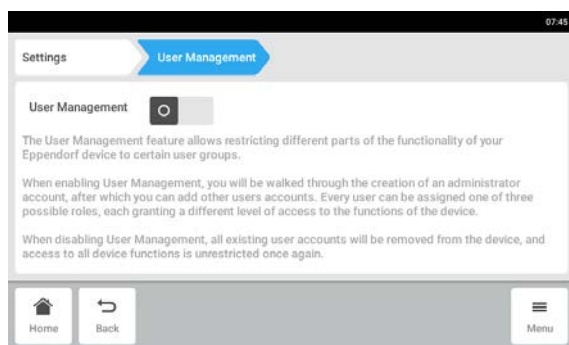

1. Tap the *Menu > Settings > User Management* buttons.
2. To enable the user management, move the *User Management* slider in *I* position. The *Login mode* window appears.

Fig. 8-1: *User Management* window

## User administration

CryoCube® F740i  
English (EN)

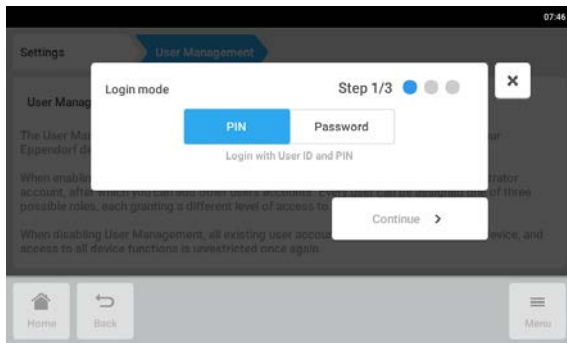

Fig. 8-2: *Login mode* window

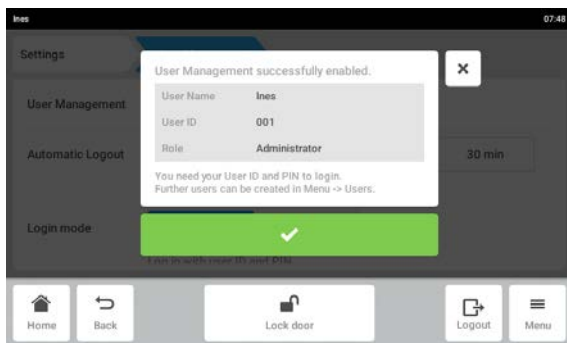

Fig. 8-3: *User management successfully enabled* window

### 8.2.2 Editing the user management

#### Prerequisites

- The device is ready for operation.
- The home screen appears on the touch screen.
- You are logged in as administrator.

3. Select whether the users shall log in with a password or PIN.
4. Tap the *Continue* button.  
The *Credentials for first administrator* window appears.
5. Enter the user name of the first administrator in the *Enter User Name* field.
6. Tap the *Continue* button.
7. Enter the password or PIN for the first administrator in the *Enter password/PIN* field. Confirm the entry in the *Repeat password/PIN* field.
8. Tap the *Confirm* button.  
The *User Management successfully enabled* window appears.  
The user management is enabled.  
The user account for the first administrator is created. The user data appears in the window.
9. Confirm the message with the green checkmark.  
The *User management successfully enabled* window appears.

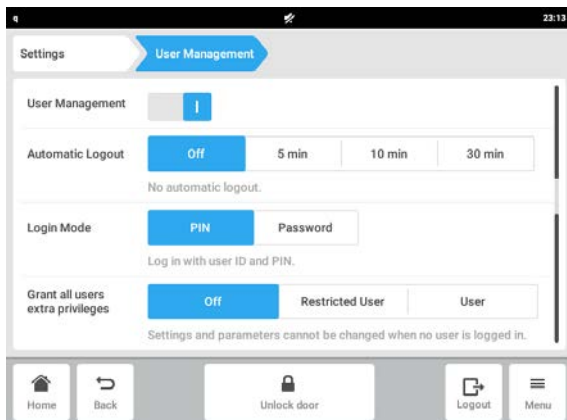

Fig. 8-4: User Management window

1. Tap the *Menu > Settings > User Management* button.
2. Define the settings for the user management.
  - *User Management*: Switch the user management on and off.
  - *Automatic Logout*: Define the time after which a user is automatically logged out if the touch screen is not used.
  - *Login Mode*: Define whether all users have to log in with a password or PIN.
  - *Grant all users extra privileges*: If this option is enabled, login is not required. The user rights for *User level 1 (Restricted user)* or *User level 2 (User)* are enabled for all users working with the device.

### 8.2.3 Disabling the user management



#### **NOTICE! Data loss in case of disabling the user management.**

Disabling the user management deletes all user accounts.

- ▶ Check whether disabling the user management is required.
- ▶ Inform all users that the user management has been deleted.

#### Prerequisites

- The device is ready for operation.
- The home screen appears on the touch screen.
- You are logged in as administrator.

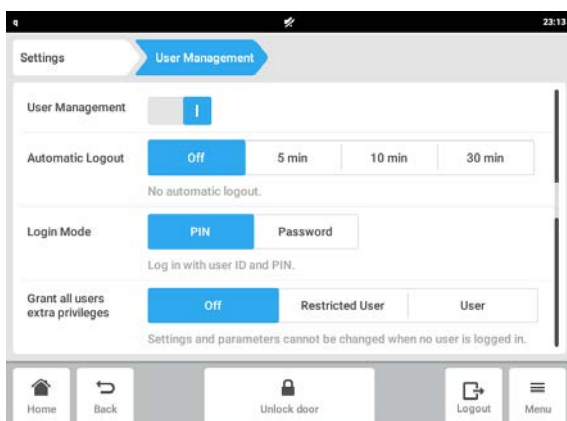

Fig. 8-5: User Management window

1. Tap the *Menu > Settings > User Management* buttons.  
The *User Management* window appears.
2. To disable the user management, move the *User Management* slider to the 0 position.  
The *Disabling User Management* window appears.
3. Tap the *Continue* button.  
The *Confirm deleting all user accounts* window appears.
4. Enter the *PIN/password*.
5. Tap the *Confirm* button.  
The user management is disabled. All user accounts are deleted.

## 8.3 Editing user accounts as administrator

### 8.3.1 Creating a user account

#### Prerequisites

- The device is ready for operation.
- The user management is enabled.
- The home screen appears on the touch screen.
- You are logged in as administrator.
- Optional a USB stick is connected to export the user data.

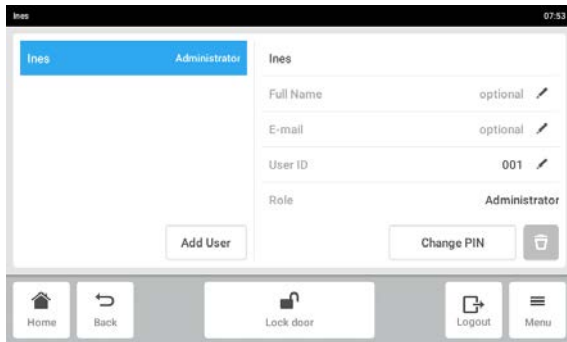

Fig. 8-6: Overview of user accounts

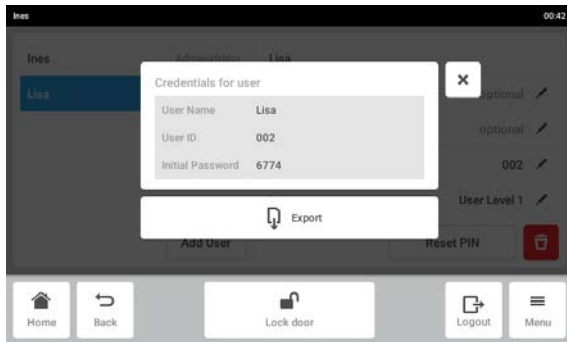

Fig. 8-7: *Credentials for user* window

### 8.3.2 Editing a user account

#### Prerequisites

- The device is ready for operation.
- The user management is enabled.
- The user account has been created.
- The home screen appears on the touch screen.
- You are logged in as administrator.

1. Tap the *Menu > Users* button.  
The overview of user accounts appears.
2. Tap the *Add User* button.  
The *Enter User Name for the new user* field appears.
3. Enter the name of the user in the field.
4. Confirm the entry with the green checkmark on the keyboard.  
The *Credentials for user* window appears.  
The user account has been created. The user data appears in the window.  
The user is assigned to the user group *User level 1 (Restricted user)*.
5. To export the user data, tap the *Export* button.  
Alternatively, you can make a note of the user data.
6. Confirm the export with the green checkmark.  
The user data is exported to the USB stick in a TXT file.
7. If the export was successful, the *Export successful* window appears.  
Confirm the message with the green checkmark.



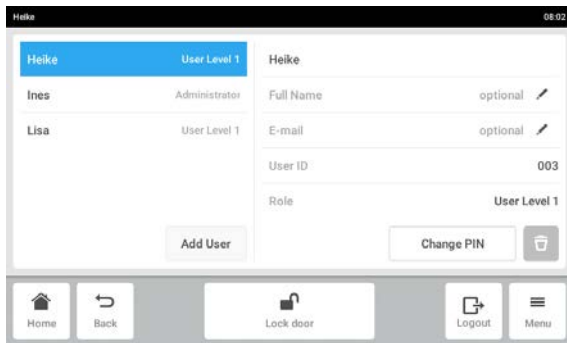

Fig. 8-8: Overview of user accounts

1. Tap the *Menu > Users* button.  
The overview of user accounts appears.
2. Highlight the user.
3. Enter the name of the user in the *Full Name* field.
4. Enter the e-mail address of the user in the *E-mail* field.
5. To change the user identification, tap the *User ID* area.  
Three suggestions for a new user ID appear.  
Alternatively, you can select a user ID.
6. To change the user group, tap the *Role* area.  
You can select the *Administrator*, *User level 1 (Restricted user)* and *User level 2 (User)* user groups.  
The selected parameters are stored and appear in the user account.

### 8.3.3 Deleting a user account

#### Prerequisites

- The device is ready for operation.
- The user management is enabled.
- The user account has been created.
- The home screen appears on the touch screen.
- You are logged in as administrator.

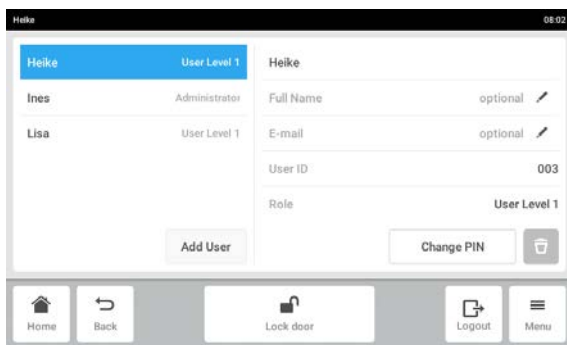
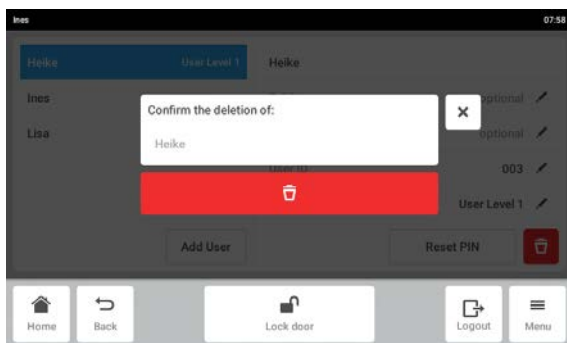

Fig. 8-9: Overview of user accounts

1. Tap the *Menu > Users* button.  
The overview of user accounts appears.
2. Highlight the user.



3. Tap the *Recycle bin* symbol.  
The *Confirm the deletion of* window appears.
4. Confirm that you want to delete the user account.  
The user account is deleted.  
The last user account of the Administrator user group cannot be deleted.

### 8.3.4 Changing the password/PIN of a user account

If a user has forgotten his password/PIN, the administrator can generate a new password.

#### Prerequisites

- The device is ready for operation.
- The user management is enabled.
- The user account has been created.
- The home screen appears on the touch screen.
- Optional a USB stick is connected to export the user data.
- You are logged in as administrator.

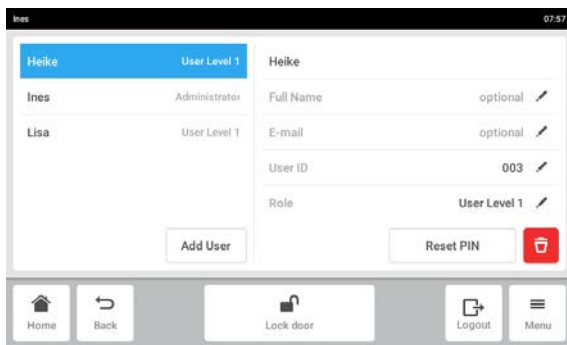

Fig. 8-10: Overview of user accounts

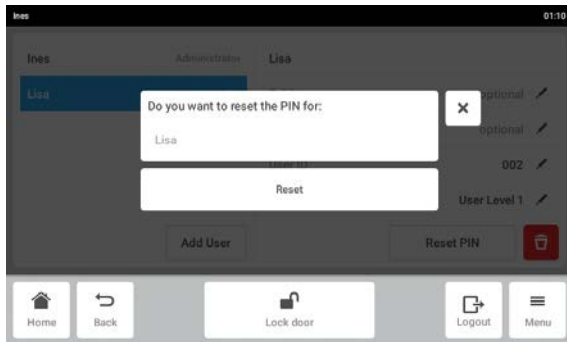

Fig. 8-11: *Do you want to reset the Password/PIN for XXX window*

1. Tap the *Menu > Users* button.  
The overview of user accounts appears.
2. Highlight the user.
3. Tap the *Reset Password/PIN* button.  
The *Do you want to reset the Password/PIN for XXX* window appears.
4. Tap the *Reset* button.  
The *New Credentials* window appears.  
The new password/PIN is created automatically.
5. To export the user data, tap the *Export* button.  
The user data is exported to the USB stick in a CSV file. Alternatively, you can make a note of the user data.
6. Confirm the export with the green checkmark.  
The user data is exported to the USB stick in a TXT file.
7. If the export was successful, the *Export successful* window appears.  
Confirm the message with the green checkmark.

### 8.3.5 Changing the password/PIN of the administrator

#### Prerequisites

- The device is ready for operation.
- The user management is enabled.
- The home screen appears on the touch screen.
- You are logged in as administrator.

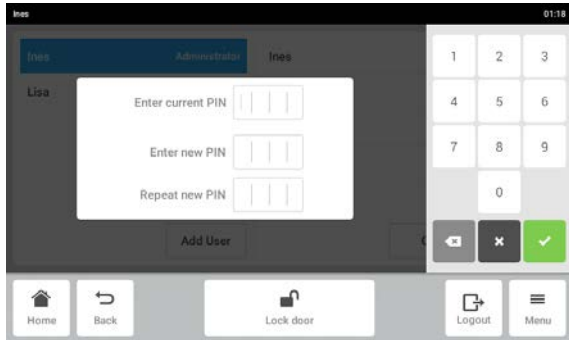

1. Tap the *Menu > Users* button.  
The overview of user accounts appears.
2. Highlight the user account of the administrator.
3. Tap the *Change password/PIN* button.
4. Enter the current password/PIN.
5. Enter and confirm the new password/PIN.
6. Confirm the entry with the green checkmark.  
The message *Password/PIN successfully changed* appears.  
The password/PIN of the administrator has been changed.

Fig. 8-12: Entering the new password/PIN

### 8.4 Editing user accounts as *User level 1 (Restricted user)* and *User level 2 (User)*

#### Prerequisites

- The device is ready for operation.
- The user management is enabled.
- Users in the *User level 1 (Restricted user)* and *User level 2 (User)* user groups have been created in the user management.
- The home screen appears on the touch screen.

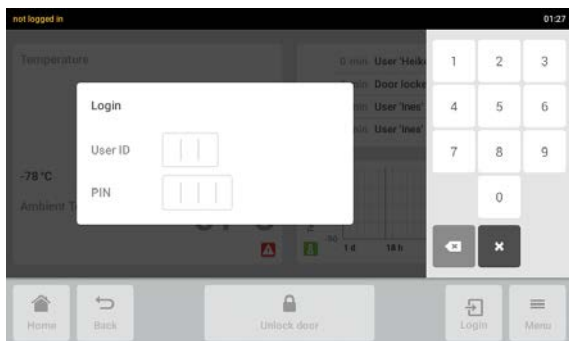

1. Press the *Login* button.  
The *Login* window opens.
2. Enter the user identification in the *Username/ User-ID* field.
3. Enter the password/PIN in the *Password/PIN* field.

Fig. 8-13: *Login* window

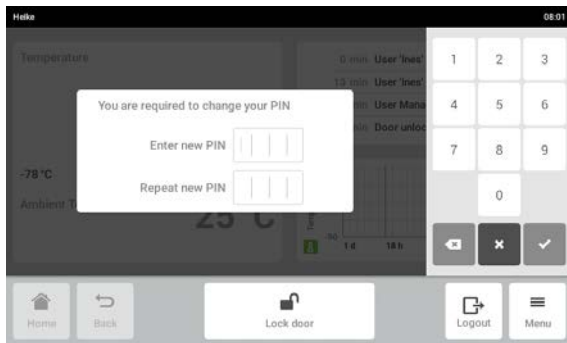

Fig. 8-14: Window at first login

4. When you log in for the first time, the *You are required to change your password/PIN* window appears.
5. Enter the new PIN in the *Enter new password/PIN* field. Confirm the new PIN in the *Repeat new password/PIN* field.  
You are logged in to the device.  
The home screen appears on the touch screen.

### 8.4.1 Logging off as a user

#### Prerequisites

- The device is ready for operation.
- The user management is enabled.
- Users in the *User level 1 (Restricted user)* and *User level 2 (User)* user groups have been created in the user management.
- You are logged in as user.

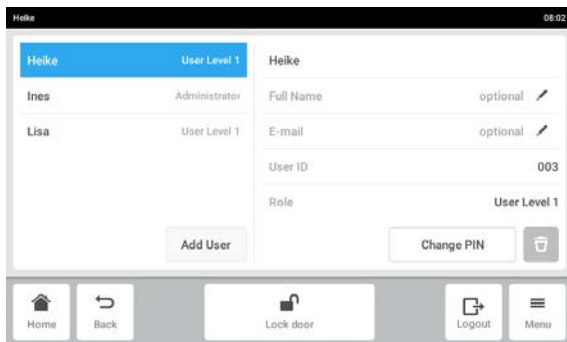

Fig. 8-15: Overview of user accounts

1. Press the *Logout* button.  
You are logged out of the device.

## 8.4.2 Administrating your own user account

Users of the *User level 1 (Restricted user)* and *User level 2 (User)* user groups can change their own password, name and e-mail address.

### Prerequisites

- The device is ready for operation.
- The user management is enabled.
- The home screen appears on the touch screen.
- You are logged in as user.

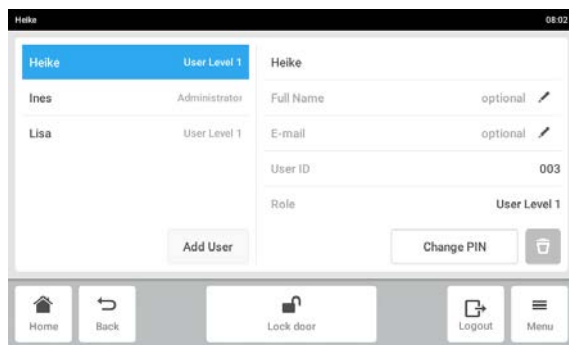

Fig. 8-16: Overview of user accounts

1. Press the *Menu > Users* button.
2. Highlight the user.
3. Change the name of the user in the *Full Name* field.
4. Change the e-mail address of the user in the *E-mail* field.
5. To change the password/PIN, press the *Change password/PIN* button. A window appears.
6. Enter the current password/PIN in the *Enter current password/PIN* field.
7. Enter the new password/PIN in the *Enter new password/PIN* and *Repeat new password/PIN* fields. If the entries differ, an error message will appear.
8. Confirm the entry with the green checkmark. The message *Password/PIN successfully changed* appears. The new password is now active.



## 9 Maintenance

### 9.1 Warning notices concerning cleaning



**DANGER! Electric shock due to the ingress of liquid.**

- ▶ Switch off the device and disconnect the power plug before starting cleaning or disinfection work.
- ▶ Do not allow any liquids to penetrate the inside of the housing.
- ▶ Do not spray clean/spray disinfect the housing.
- ▶ Only plug the device back in if it is completely dry, both inside and outside.



**NOTICE! Damage from the use of aggressive chemicals.**

- ▶ Do not use any aggressive chemicals on the device or its accessories, such as strong and weak bases, strong acids, acetone, formaldehyde, halogenated hydrocarbons or phenol.
- ▶ If the device has been contaminated by aggressive chemicals, clean it immediately using a mild cleaning agent.

**Personal protective equipment:**

- Protective clothing, protective gloves and safety shoes.
- Protective goggles
- Dust protection mask

### 9.2 Service schedule

Service	Service cycle
Defrost the device.	As required
Clean the interior and exterior of the device.	As required
Clean the seals.	1 x a month
Clean the vent tube.	If there is ice or snow in the vent tube.
Clean the air intake grille.	Every 3 months under normal ambient conditions. Clean more frequently if the environment is very dusty or dirty.
Clean the air filter.	Every 3 months under normal ambient conditions. Clean more frequently if the environment is very dusty or dirty.
Lubricate the hinges on the outer door.	annually
Check the seals on the outer door.	annually
Lubricate the door handle on the outer door.	annually

## 9.3 Defrosting the device



**CAUTION! Danger of slipping due to melt water.**

Puddles may form on the laboratory floor when defrosting the device.

- ▶ Clean up the melt water immediately.



**NOTICE! Material damage due to scraping off ice.**

Removing ice with a sharp object can damage the device.

- ▶ Wait until the ice has thawed by itself.
- 

### Tools and auxiliary equipment

- Personal protective equipment: Cold protection gloves, protective goggles, dust protection mask
- ULT freezer for the storage of samples during defrosting
- Material for absorbing the melt water
- "Defrosting device" notice sign

1. Transfer the samples to the replacement device.
2. Put up the notice sign.
3. Switch off the device and disconnect it from the mains/power line (see p. 35).
4. Open the outer and inner doors.
5. Wait until the ice has melted.
6. Absorb the melt water.
7. Dry the interior of the device.
8. Connect the device to the mains/power line.
9. Put the device into operation.

## 9.4 Cleaning and decontamination

### 9.4.1 Cleaning the device

#### Tools and auxiliary equipment

- Water
- Mild cleaning agent
- Soft, lint-free cloth
- The inner shelves have been disassembled

#### Prerequisites

- When cleaning the interior: The device is switched off and disconnected from the mains/power line.
- The device is defrosted.

1. Moisten the lint-free cloth with water and cleaning agent.
2. Clean the surfaces.



## 9.4.2 Cleaning and disinfecting the touch screen

Tools and auxiliary equipment

- Laboratory cleaner
- Lint-free cloth
- Disinfectant: Ethanol 70%, sodium hypochlorite solution 1%, Dismozon pur, Hexaquart S, Biozid ZF or another suitable disinfectant

1. Lock the touch screen.
2. Moisten the lint-free cloth with laboratory cleaner or disinfectant.
3. Wipe the touch screen with the cloth.
4. Unlock the locked touch screen.

## 9.4.3 Cleaning the seals

Tools and auxiliary equipment

- Dry soft lint-free cloth

1. Wipe the seal with a soft lint-free cloth.
2. Wipe the surface on which the seal rests with a soft lint-free cloth.

## 9.4.4 Cleaning the vent tube

Tools and auxiliary equipment

- Brush
- Ice scraper

1. Use the brush to sweep the snow off the vent tube.
2. Use the ice scraper to scrape the ice off the vent tube.

### 9.4.5 Cleaning the air filter and the air intake grille



**CAUTION! Failure of cooling due to a blocked air filter.**

If the air filter is blocked, the refrigerant will not be liquefied. This will damage the compressor.

- ▶ Check regularly that the air flow into the device is not obstructed.

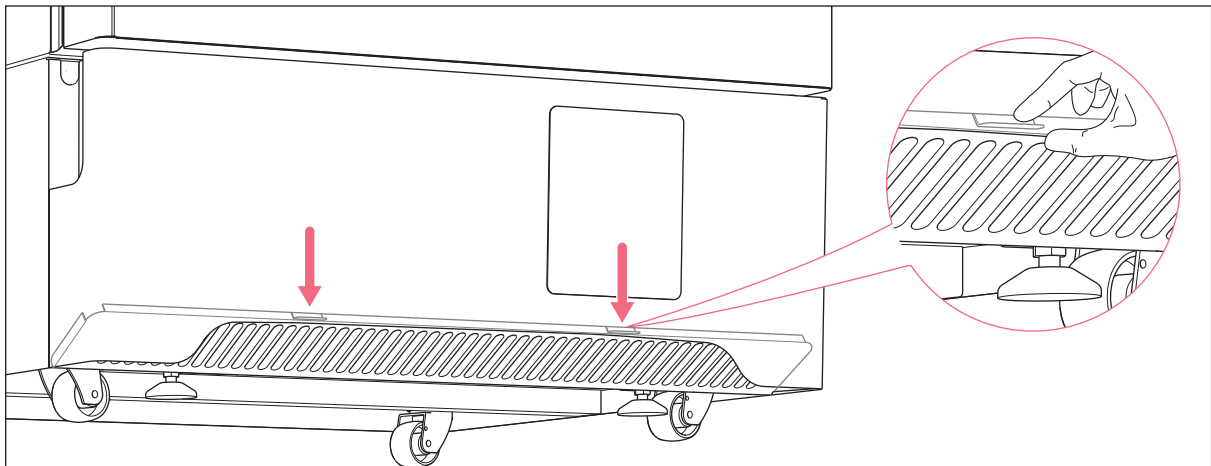

Fig. 9-1: Folding down the air intake grille

An airflow from the surroundings flows through the air filter to the condenser. The airflow carries the heat away from the condenser.

The air filter protects the condenser and the components behind it against contamination and dirt. If the air filter is dirty, not enough air will reach the condenser. The condenser will overheat, the refrigeration cycle may fail.

#### Tools and auxiliary equipment

- Vacuum cleaner
- Warm water

1. Place your fingers into the recesses on the air intake grille. Press the air intake grille downwards.  
The air intake grille folds down.
2. Remove the air filter.
3. Clean the air intake grille with the vacuum cleaner.
4. Alternatively, clean the air intake grille with a soft brush.
5. Remove the coarse dirt from the air filter by vacuuming or tapping it.
6. Clean the air filter with warm water.
7. Let the air filter dry.
8. Insert the air filter.
9. Press the air intake grille upwards and close it.

### 9.4.6 Decontaminating the interior and the inner shelves

The interior and the inner shelves are made of stainless steel.

Tools and auxiliary equipment

- Decontamination agent consisting of 70% isopropyl alcohol, 30% distilled water
- Soft, lint-free cloth

Prerequisites

- The device is switched off and disconnected from the mains/power line.
- The device is defrosted.
- The inner shelves have been disassembled.

1. Moisten the lint-free cloth with decontamination agent.
2. Clean the surfaces with the lint-free cloth.  
The surfaces are moistened with decontamination agent.
3. Allow the decontamination agent to take effect.
4. Wipe off the decontamination agent with deionized water.
5. Allow the surfaces to dry.

## 9.5 Lubricating the device

Tools and auxiliary equipment

- Invisilube® spray lubricant
- Alternatives: light oil, general-purpose oil, spray oil

1. Lubricate the hinges on the outer door.
2. Open the outer door.
3. Lightly oil all moving parts of the handle mechanism.
4. Wipe off any excess oil.



Do not lubricate the hinges and locking mechanism of the inner doors.

## 9.6 Disassembling the inner shelf from the device

- ▶ Lift the inner shelf upwards out of the device.

## 9.7 Shipping the device

---



**DANGER! Risk of injury due to tilting of the device**

If the device tips over and falls on a person, the person may sustain fatal injuries.

- ▶ Transport the device with a sufficient number of helpers.
  - ▶ Do not transport the device over ramps at an angle > 17 % (10°). Transport the device sideways over ramps.
  - ▶ Only lift the device with a transport aid.
- 



**WARNING! Personal injury due to contamination.**

People may get contaminated if you store or ship a contaminated device.

- ▶ Clean and decontaminate the device before shipping or storage.
- 



**NOTICE! Damage as a result of incorrect packing.**

Eppendorf AG is not liable for damage caused by improper packing.

- ▶ The device may only be stored and transported in its original packaging.
  - ▶ If you do not have the original packing, request original packing from Eppendorf AG.
- 

### Prerequisites

- The device has been cleaned and decontaminated.
- The original packing is available.

1. Download the "Decontamination declaration for product returns" from [www.eppendorf.com](http://www.eppendorf.com).
2. Complete the decontamination declaration.
3. Pack the device.
4. Put the decontamination declaration into the packaging.
5. Send the device to Eppendorf AG or an authorized service center.

## 10 Troubleshooting

### 10.1 General errors

If you cannot remedy an error with the recommended measures, please contact your local Eppendorf partner. The addresses can be found on the Internet under [www.eppendorf.com](http://www.eppendorf.com).

#### 10.1.1 Outer door

Problem	Cause	Solution
The outer door cannot be opened.	<ul style="list-style-type: none"> <li>The door handle is locked.</li> </ul>	<ul style="list-style-type: none"> <li>▶ Unlock the door handle.</li> </ul>
The outer door cannot be opened.	<ul style="list-style-type: none"> <li>The vent tube is blocked. The negative pressure in the interior prevents the outer door from being opened.</li> </ul>	<ul style="list-style-type: none"> <li>▶ Wait until pressure compensation has taken place. The balancing of pressure takes 1 to 2 hours.</li> <li>▶ After opening the outer door, remove the ice from the vent tube (see <i>Cleaning the vent tube on p. 73</i>).</li> </ul>
The outer door cannot be opened.	<ul style="list-style-type: none"> <li>The touch screen does not respond.</li> </ul>	<ul style="list-style-type: none"> <li>▶ Open the outer door with the emergency release (see <i>Emergency release on p. 78</i>).</li> </ul>

#### 10.1.2 Software error messages

Problem	Cause	Solution
<i>Cabinet temperature sensor failure</i>	<ul style="list-style-type: none"> <li>The temperature sensor that measures the temperature in the interior is not working properly.</li> </ul>	<ul style="list-style-type: none"> <li>▶ Contact your local Eppendorf partner.</li> </ul>
<i>Heat exchanger temperature sensor failure</i>	<ul style="list-style-type: none"> <li>The temperature probe at the heat exchanger is not working properly.</li> </ul>	<ul style="list-style-type: none"> <li>▶ Contact your local Eppendorf partner.</li> </ul>
<i>Condenser temperature sensor failure</i>	<ul style="list-style-type: none"> <li>The temperature probe at the condenser is not working properly.</li> </ul>	<ul style="list-style-type: none"> <li>▶ Contact your local Eppendorf partner.</li> </ul>
<i>Ambient temperature sensor failure</i>	<ul style="list-style-type: none"> <li>The temperature probe for the ambient temperature is not working properly.</li> </ul>	<ul style="list-style-type: none"> <li>▶ Contact your local Eppendorf partner.</li> </ul>
<i>Fan failure</i>	<ul style="list-style-type: none"> <li>The fan is not working properly.</li> </ul>	<ul style="list-style-type: none"> <li>▶ Contact your local Eppendorf partner.</li> </ul>
<i>First stage overpressure.</i>	<ul style="list-style-type: none"> <li>The refrigerant pressure in the first stage refrigeration system is too high.</li> </ul>	<ul style="list-style-type: none"> <li>▶ Contact your local Eppendorf partner.</li> </ul>
<i>Second stage overpressure.</i>	<ul style="list-style-type: none"> <li>The refrigerant pressure in the second stage refrigeration system is too high.</li> </ul>	<ul style="list-style-type: none"> <li>▶ Contact your local Eppendorf partner.</li> </ul>
<i>Low battery voltage.</i>	<ul style="list-style-type: none"> <li>The battery charging status is low.</li> </ul>	<ul style="list-style-type: none"> <li>▶ To charge the battery, switch on the battery switch.</li> <li>▶ Contact your local Eppendorf partner.</li> </ul>

## 10.2 Emergency release

If the outer door does not open, you can release the electronic lock manually. To this end, use the emergency release key included in the delivery package.

1. Insert the emergency release key in the mechanical lock on the outer door.
2. Open the lock.
3. Open the outer door using the handle.

## 10.3 After a mains/power failure

If the mains/power supply to the device is interrupted, the message *Mains/Power Failure* will appear on the touch screen. The audible alarm sounds and the touch screen flashes at intervals of 10 seconds. The LED next to the touch screen flashes red.

After the mains/power supply to the device has been restored, the alarm and LED will be disabled. The administrator must acknowledge the alarm message.

If the mains/power supply was briefly interrupted and the actual temperature in the interior is below the high alarm, the device will continue to operate normally.

If the mains/power supply was interrupted for a longer time, the actual temperature in the interior can be above the high alarm. The message *Temperature above warning limit* will then appear on the touch screen. If the temperature is still above the high alarm after the alarm delay time has elapsed, the device will trigger an alarm again.

## 10.4 Heating of the interior

When the doors of the device are opened, warm air enters the device. The temperature inside the device increases.

There are two alarms to prevent the actual temperature in the interior from increasing uncontrolledly.

- Alarm due to the outer door being open (*Door open alarm*)
- Alarm due to the temperature inside the device rising above the alarm limit (*high alarm*)

- ▶ To avoid the inside of the device heating up, only open the outer door and the inner doors briefly.

## 11 Transport, storage and disposal

### 11.1 Transport

---

**DANGER! Risk of injury due to tilting of the device.**

If the device tips over and falls on a person, the person may sustain fatal injuries.

- ▶ Transport the device with a sufficient number of helpers.
  - ▶ Do not transport the device over ramps at an angle  $> 17\%$  ( $10^\circ$ ). Transport the device sideways over ramps.
  - ▶ Only lift the device with a transport aid.
- 

**CAUTION! Personal injury due to little ground clearance.**

Feet can easily get trapped under the device.

- ▶ Wear safety shoes with steel toes.
- 

**NOTICE! Damage to device due to lifting the device without the original pallet.**

Lifting the device without the original pallet will damage the base of the device.

1. Place the device on the original pallet.
  2. Secure the device.
  3. Lift the device with a transport aid.
- 

**NOTICE! Damage to the compressors and the refrigeration cycle due to tilting of the device.**

Tilting the device or transporting it in a horizontal position will damage the compressors and the refrigeration cycle. Refrigerant and oil can leak out.

- ▶ Transport the device in an upright position.
  - ▶ After setting up the device, wait 6 h before switching the device on.
- 

**NOTICE! Damage due to exposing the device to shocks.**

Shocks may dislodge the compressors from the brackets.

- ▶ Move the device with due caution and care.
  - ▶ Do not knock the device into anything.
  - ▶ Do not expose the device to shocks.
- 

**NOTICE! Damage to the control panel.**

The control panel protrudes over the door. The control panel can get damaged during transport.

- ▶ Only transport the device with the transport protection attached to the control panel.
-

### 11.1.1 Preparing the device for transport

#### Prerequisites

- Replacement device for the storage of samples
  - Open-end wrench
1. Transfer the samples and racks to the replacement device.  
The device is empty.
  2. Unlock the switch locking plate and remove the cover.
  3. Switch off the battery switch.
  4. Switch off the device using the mains/power switch.
  5. Disconnect the mains/power cord from the mains/power supply.
  6. Remove the safety clamp.
  7. Remove the mains/power cord from the device.
  8. Use the open-end wrench to turn the leveling feet upward.

### 11.1.2 Transporting the device

Proceed as follows to transport the device.

#### Personal protective equipment

- Protective clothing, safety shoes.

#### Tools and auxiliary equipment

- Transport aid
- Original pallet

#### General transport

1. Transport the device in an upright position.
2. Wheel the device to its new location.

#### Lifting the device

3. Place the device on the original pallet.
4. Secure the device on the original pallet.
5. Lift the device with a transport aid.

#### Sloping surfaces

6. Transport the device sideways over ramps.
7. Do not transport the device over ramps at an angle > 17 % (10°).

#### Narrow passageways

8. Open the door of the device 180°.
9. Push the device, with one side panel to the front, through the passageway.

If the passageway is too narrow for the device, housing parts may have to be disassembled. Contact your local Eppendorf partner for more information.



If you need help to transport the device, contact the authorized service.



	Air temperature	Relative humidity	Atmospheric pressure
General transport	-20 °C – 35 °C	10 % – 91 %	30 kPa – 106 kPa
Air freight	-20 °C – 35 °C	10 % – 91 %	30 kPa – 106 kPa

## 11.2 Storage

	Air temperature	Relative humidity	Atmospheric pressure
In transport packing	-20 °C – 35 °C	10 % – 91 %	70 kPa – 106 kPa
Without transport packing	-20 °C – 35 °C	10 % – 91 %	70 kPa – 106 kPa

## 11.3 Prepare the device for disposal



### **DANGER! Danger of suffocation due to closed outer door**

The outer door cannot be opened from inside. Persons inside the device can suffocate.

- ▶ To prevent the outer door from accidentally closing, disassemble the actuator and the retaining plate.
- ▶ Dispose of the device after that.

### 11.3.1 Disassembling the actuator and the retaining plate

1. Undo the 3 screws on the retaining plate.
2. Carefully remove the retaining plate.
3. Cut off the actuator cable.
4. Unscrew the actuator from the latch.

## 11.4 Disposal

In case the product is to be disposed of, the relevant legal regulations are to be observed.

### **Information on the disposal of electrical and electronic devices in the European Community:**

Within the European Community, the disposal of electrical devices is regulated by national regulations based on EU Directive 2012/19/EU pertaining to waste electrical and electronic equipment (WEEE).

According to these regulations, any devices supplied after August 13, 2005, in the business-to-business sphere, to which this product is assigned, may no longer be disposed of in municipal or domestic waste. To document this, they have been marked with the following identification:



Because disposal regulations may differ from one country to another within the EU, please contact your supplier if necessary.

## 12 Technical data

### 12.1 Power supply

Mains/power connection	100 V – 230 V
Frequency	50 Hz - 60 Hz
Current consumption	100 V, 15 A 120 V, 12 A 208 V, 9 A 230 V, 6 A
EMC: Noise emission (radio interference)	CISPR 11, IEC/DIN EN 55011 class A - for industrial use
EMC: Noise immunity	IEC/EN 61326-1
Overvoltage category	II
Degree of pollution	2

### 12.2 Ambient conditions

Environment	For indoor use only.
Ambient temperature	15 °C – 32 °C
Relative humidity	Maximum 80 %, non-condensing.
Atmospheric pressure	80 kPa – 106 kPa

### 12.3 Weight

Device	Model with 3 compartments	Model with 5 compartments
CryoCube F740i	Approx. 330 kg	Approx. 340 kg
CryoCube F740hi	Approx. 330 kg	Approx. 340 kg
CryoCube F740hiw	Approx. 330 kg	Approx. 340 kg
CryoCube F740iw	Approx. 330 kg	Approx. 340 kg

## 12.4 Dimensions

### 12.4.1 External dimensions

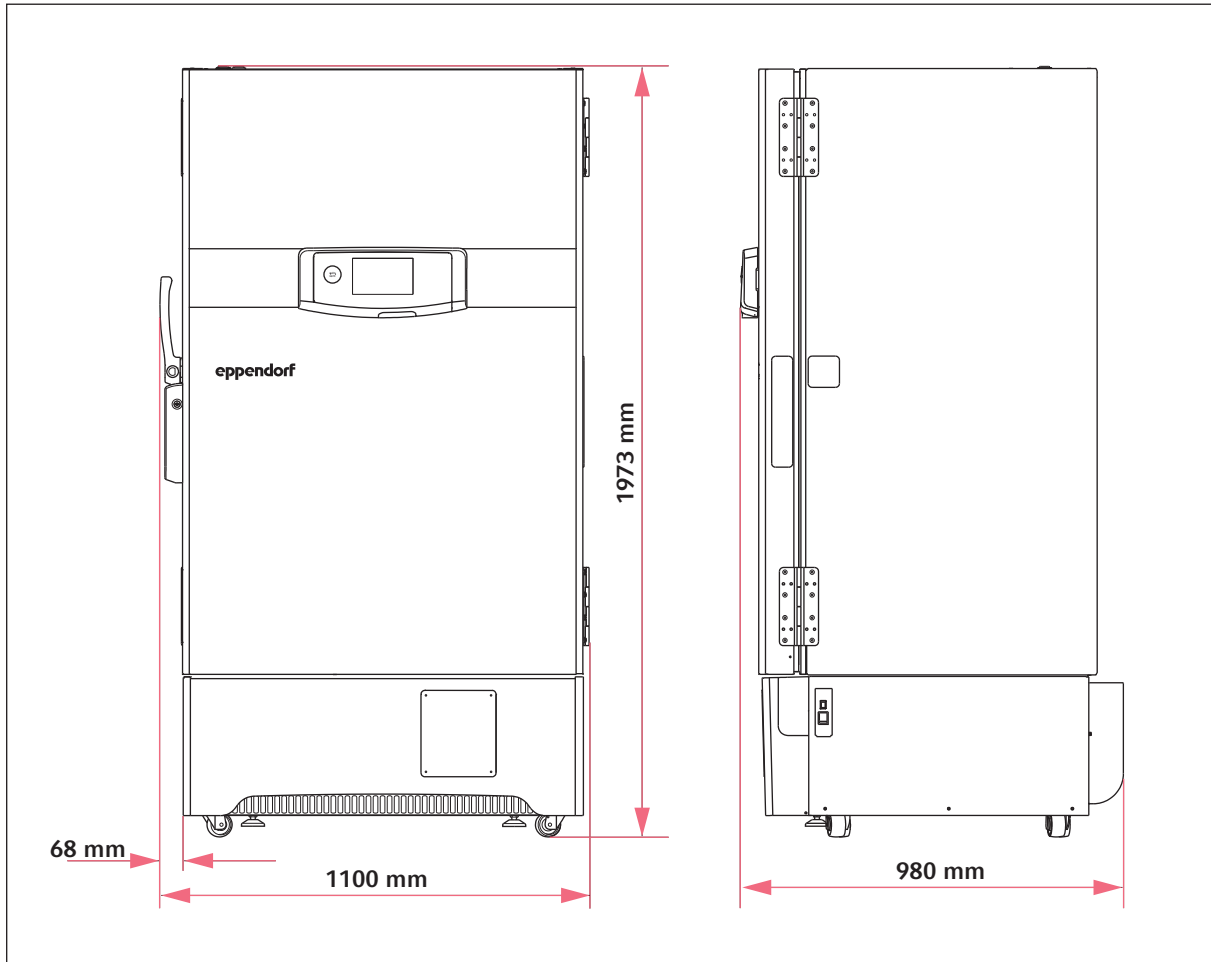

Fig. 12-1: External dimensions

### 12.4.2 Internal dimensions

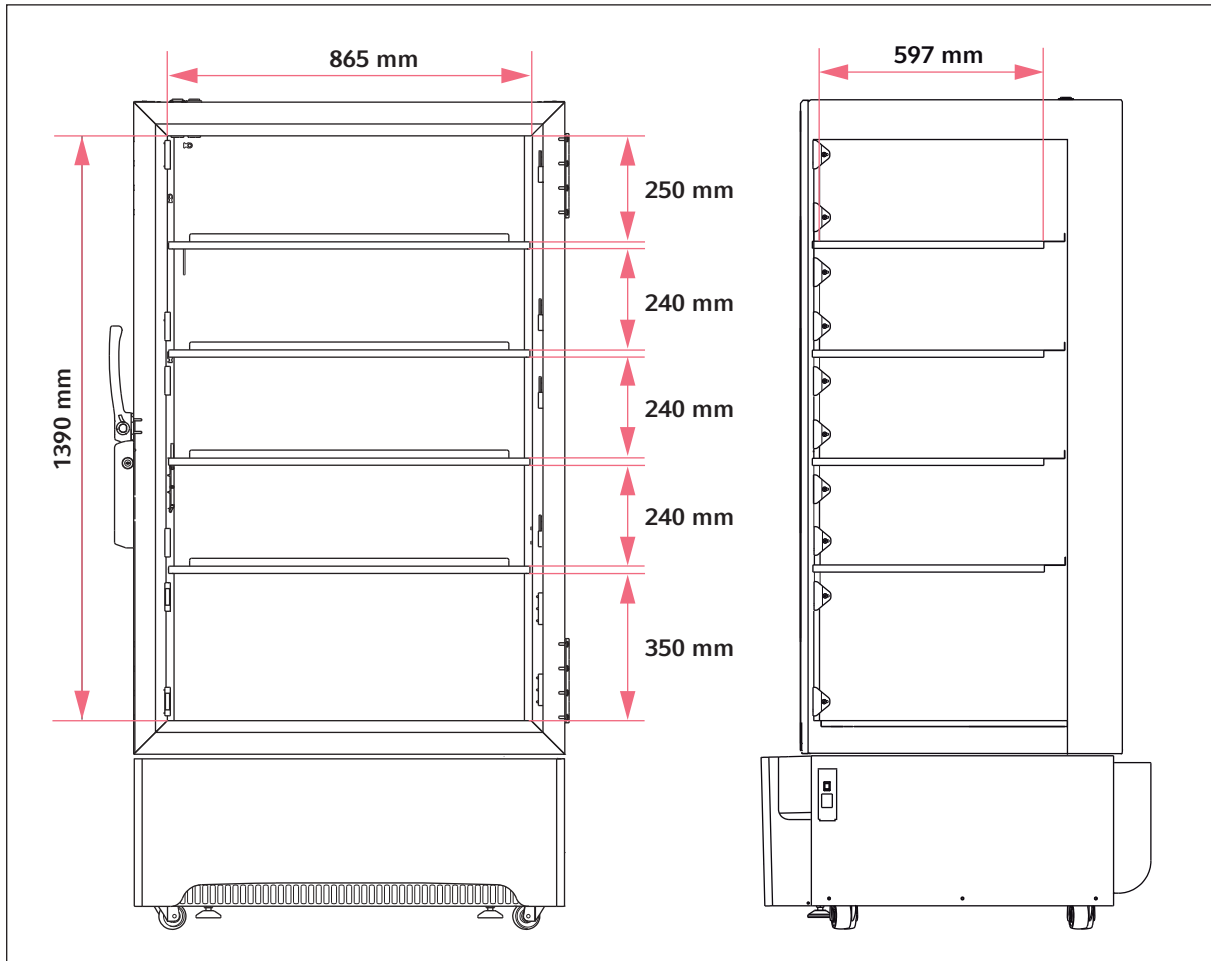

Fig. 12-2: Internal dimensions for devices with 5 inner compartments

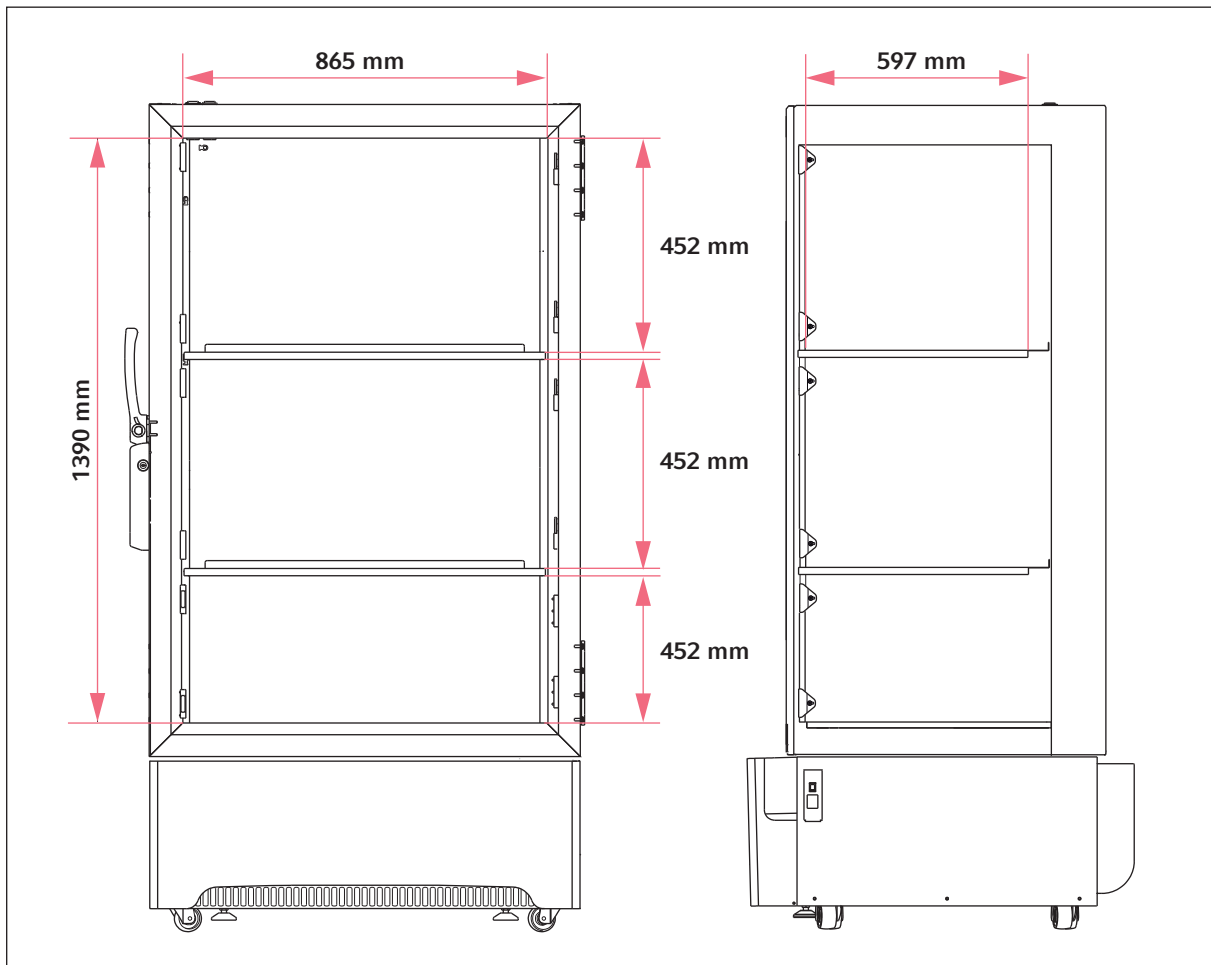

Fig. 12-3: Internal dimensions for devices with 3 inner compartments

### 12.4.3 Packing dimensions

Width	1200 mm
Depth	1030 mm
Height	2220 mm

## 12.5 Interfaces

USB	
Ethernet	Connection to a monitoring system
BMS	Remote alarm
Serial interface	RS-485

Only devices which meet the requirements of IEC 950/EN 60950-1 (UL 1950) standards may be connected to the interfaces.

## 12.6 Additional specifications

### 12.6.1 Temperature control

Adjustment range	-86 °C to -50 °C
------------------	------------------

### 12.6.2 Interior

Capacity	740 L
Maximum carrying capacity per inner shelf	150 kg

### 12.6.3 Materials

Outer door insulation	Vacuum insulation panels Polyurethane foam
Device insulation	Vacuum insulation panels Polyurethane foam
Interior	Stainless steel (304 2B)

### 12.6.4 Cooling

CryoCube F740i, CryoCube F740hi	Air cooling
CryoCube F740hiw, CryoCube F740iw	Water cooling

## 12.7 Refrigerant

Device	Refrigeration cycle 1	Refrigeration cycle 2	Refrigeration cycle 2 additive
CryoCube F740i	R-404A (200 g)	R-508B (274 g)	R-290 (10 g)
CryoCube F740hi	R-290 (110 g)	R-170 (98 g)	-
CryoCube F740hiw	R-290 (76 g)	R-170 (98 g)	-
CryoCube F740iw	R-404A (200 g)	R-508B (274 g)	R-290 (10 g)

Refrigerant	Components
R-170	Ethane
R-290	Propane
R-404A	Pentafluoroethane (R-125), tetrafluoroethane (R-134A), trifluoroethane (R-143A)
R-508B	Trifluoromethane, hexafluoroethane (R-116)

## 12.8 Water connection

Connection for water inlet and water outlet	Whitworth pipe thread 15 mm × 12.7 mm according to DIN 2999
Water temperature	7 °C – 25 °C
Water pressure	100 kPa – 1000 kPa The difference in pressure between the water inlet and the water outlet is 50 Pa
Water flow rate	29 L/h
Water quality	Clean Free of particles that could clog the valves and the temperature sensors
Water filter	If well water is used, place the filter upstream of the water inlet. Mesh width: 0.25 mm (60 mesh)



## 13 Ordering information

### 13.1 Device

Order no. (International)	Description
	<b>CryoCube F740i ULT freezer</b> 230 V/50 Hz, with EU-plug
F740310031	5 inner compartments, outer door handle left, air-cooled
F740310011	3 inner compartments, outer door handle left, air-cooled
F740310041	5 inner compartments, outer door handle right, air-cooled
F740310021	3 inner compartments, outer door handle right, air-cooled
	<b>CryoCube F740iw ULT freezer</b> 230 V/50 Hz, with EU-plug
F740310131	5 inner compartments, outer door handle left, water-cooled
F740310111	3 inner compartments, outer door handle left, water-cooled
	<b>CryoCube F740hi ULT freezer</b> 230 V/50 Hz, with EU-plug
F740320031	5 inner compartments, outer door handle left, air-cooled
F740320011	3 inner compartments, outer door handle left, air-cooled
F740320041	5 inner compartments, outer door handle right, air-cooled
F740320021	3 inner compartments, outer door handle right, air-cooled
	<b>CryoCube F740hiw ULT freezer</b> 230 V/50 Hz, with EU-plug
F740320131	5 inner compartments, outer door handle left, water-cooled
F740320111	3 inner compartments, outer door handle left, water-cooled
Order no. (International)	Description
	<b>CryoCube F740i ULT freezer</b> 230 V/50 Hz, with UK-plug
F740310032	5 inner compartments, outer door handle left, air-cooled
F740310012	3 inner compartments, outer door handle left, air-cooled
F740310042	5 inner compartments, outer door handle right, air-cooled
F740310022	3 inner compartments, outer door handle right, air-cooled
	<b>CryoCube F740iw ULT freezer</b> 230 V/50 Hz, with UK-plug
F740310132	5 inner compartments, outer door handle left, water-cooled
F740310112	3 inner compartments, outer door handle left, water-cooled
	<b>CryoCube F740hi ULT freezer</b> 230 V/50 Hz, with UK-plug
F740320032	5 inner compartments, outer door handle left, air-cooled
F740320012	3 inner compartments, outer door handle left, air-cooled
F740320042	5 inner compartments, outer door handle right, air-cooled
F740320022	3 inner compartments, outer door handle right, air-cooled
	<b>CryoCube F740hiw ULT freezer</b> 230 V/50 Hz, with UK-plug
F740320132	5 inner compartments, outer door handle left, water-cooled
	<b>CryoCube F74h0iw ULT freezer</b> 230 V/50 Hz, with UK-plug
F740320112	3 inner compartments, outer door handle left, water-cooled

## Ordering information

CryoCube® F740i  
English (EN)

Order no. (International)	Description
	<b>CryoCube F740i ULT freezer</b> 115 V/60 Hz, with US-plug
F740210035	5 inner compartments, outer door handle left, air-cooled
F740210015	3 inner compartments, outer door handle left, air-cooled
F740210045	5 inner compartments, outer door handle right, air-cooled
F740210025	3 inner compartments, outer door handle right, air-cooled
	<b>CryoCube F740i ULT freezer</b> 208 V/60 Hz, with US-plug
F740410035	5 inner compartments, outer door handle left, air-cooled
F740410015	3 inner compartments, outer door handle left, air-cooled
F740410045	5 inner compartments, outer door handle right, air-cooled
F740410025	3 inner compartments, outer door handle right, air-cooled
	<b>CryoCube F740iw ULT freezer</b> 115 V/60 Hz, with US-plug
F740210135	5 inner compartments, outer door handle left, water-cooled
F740210115	3 inner compartments, outer door handle left, water-cooled
	<b>CryoCube F740iw ULT freezer</b> 208 V/60 Hz, with US-plug
F740410135	5 inner compartments, outer door handle left, water-cooled
F740410115	3 inner compartments, outer door handle left, water-cooled
	<b>CryoCube F740hi ULT freezer</b> 115 V/60 Hz, with US-plug
F740220035	5 inner compartments, outer door handle left, air-cooled
F740220015	3 inner compartments, outer door handle left, air-cooled
F740220045	5 inner compartments, outer door handle right, air-cooled
F740220025	3 inner compartments, outer door handle right, air-cooled
	<b>CryoCube F740hi ULT freezer</b> 208 V/60 Hz, with US-plug
F740420035	5 inner compartments, outer door handle left, air-cooled
F740420015	3 inner compartments, outer door handle left, air-cooled
F740420045	5 inner compartments, outer door handle right, air-cooled
F740420025	3 inner compartments, outer door handle right, air-cooled
	<b>CryoCube F740hiw ULT freezer</b> 115 V/60 Hz, with US-plug
F740220135	5 inner compartments, outer door handle left, water-cooled
F740220115	3 inner compartments, outer door handle left, water-cooled
	<b>CryoCube F740hiw ULT freezer</b> 208 V/60 Hz, with US-plug
F740420135	5 inner compartments, outer door handle left, water-cooled
F740420115	3 inner compartments, outer door handle left, water-cooled

## 13.2 Accessories

### 13.2.1 Back-up systems

Order no. (International)	Description
	<b>CO2 back-up system</b> Innova and Green "G"
U9043-0002	120 V - 220 V/60 Hz
U9043-0004	230 V/ 50 Hz
	<b>LN2 back-up system</b> Innova and Green "G"
U9044-0002	120 V - 220 V/60 Hz
U9044-0004	230 V/ 50 Hz

### 13.2.2 Temperature monitoring

Order no. (International)	Description
	<b>Eppendorf TCA-3 Temperature Monitor</b>
P0625-2050	230 V/50 Hz

### 13.2.3 Chart recorder

Order no. (International)	Description
	<b>chart recorder type 2</b>
F652999001	100 V/120 V, 50 Hz - 60 Hz
F652999002	208 V - 230 V, 50 Hz -60 Hz
	<b>Discs for chart recorder type 2</b> - 100 °C - 0 °C
F651999017	60 pieces
	<b>Pens for chart recorder type 2</b>
F651999018	3 pieces

**Ordering information**

CryoCube® F740i

English (EN)



# Evaluate Your Manual

Give us your feedback.

[www.eppendorf.com/manualfeedback](http://www.eppendorf.com/manualfeedback)

**Your local distributor: [www.eppendorf.com/contact](http://www.eppendorf.com/contact)**

Eppendorf AG · Barkhausenweg 1 · 22339 Hamburg · Germany  
[eppendorf@eppendorf.com](mailto:eppendorf@eppendorf.com) · [www.eppendorf.com](http://www.eppendorf.com)